

# INSTRUCTION MANUAL



## ***CC5MPX Series*** ***Digital Network Camera***

---

November 2016



Copyright © 2015  
Campbell Scientific (Canada) Corp.



# Guarantee

---

This equipment is guaranteed against defects in materials and workmanship. We will repair or replace products which prove to be defective during the guarantee period as detailed on your invoice, provided they are returned to us prepaid. The guarantee will not apply to:

- Equipment which has been modified or altered in any way without the written permission of Campbell Scientific
- Batteries
- Any product which has been subjected to misuse, neglect, acts of God or damage in transit.

Campbell Scientific will return guaranteed equipment by surface carrier prepaid. Campbell Scientific will not reimburse the claimant for costs incurred in removing and/or reinstalling equipment. This guarantee and the Company's obligation thereunder is in lieu of all other guarantees, expressed or implied, including those of suitability and fitness for a particular purpose. Campbell Scientific is not liable for consequential damage.

Please inform us before returning equipment and obtain a Repair Reference Number whether the repair is under guarantee or not. Please state the faults as clearly as possible, and if the product is out of the guarantee period it should be accompanied by a purchase order. Quotations for repairs can be given on request. It is the policy of Campbell Scientific to protect the health of its employees and provide a safe working environment, in support of this policy a "Declaration of Hazardous Material and Decontamination" form will be issued for completion.

When returning equipment, the Repair Reference Number must be clearly marked on the outside of the package. Complete the "Declaration of Hazardous Material and Decontamination" form and ensure a completed copy is returned with your goods. Please note your Repair may not be processed if you do not include a copy of this form and Campbell Scientific Ltd reserves the right to return goods at the customers' expense.

Note that goods sent air freight are subject to Customs clearance fees which Campbell Scientific will charge to customers. In many cases, these charges are greater than the cost of the repair.



Campbell Scientific Ltd,  
80 Hathern Road,  
Shepshed, Loughborough, LE12 9GX, UK  
Tel: +44 (0) 1509 601141  
Fax: +44 (0) 1509 601091  
Email: [support@campbellsci.co.uk](mailto:support@campbellsci.co.uk)  
[www.campbellsci.co.uk](http://www.campbellsci.co.uk)



# Precautions

---

DANGER — MANY HAZARDS ARE ASSOCIATED WITH INSTALLING, USING, MAINTAINING, AND WORKING ON OR AROUND **TRIPODS, TOWERS, AND ANY ATTACHMENTS TO TRIPODS AND TOWERS SUCH AS SENSORS, CROSSARMS, ENCLOSURES, ANTENNAS, ETC.** FAILURE TO PROPERLY AND COMPLETELY ASSEMBLE, INSTALL, OPERATE, USE, AND MAINTAIN TRIPODS, TOWERS, AND ATTACHMENTS, AND FAILURE TO HEED WARNINGS, INCREASES THE RISK OF DEATH, ACCIDENT, SERIOUS INJURY, PROPERTY DAMAGE, AND PRODUCT FAILURE. TAKE ALL REASONABLE PRECAUTIONS TO AVOID THESE HAZARDS. CHECK WITH YOUR ORGANIZATION'S SAFETY COORDINATOR (OR POLICY) FOR PROCEDURES AND REQUIRED PROTECTIVE EQUIPMENT PRIOR TO PERFORMING ANY WORK.

Use tripods, towers, and attachments to tripods and towers only for purposes for which they are designed. Do not exceed design limits. Be familiar and comply with all instructions provided in product manuals. Manuals are available at [www.campbellsci.eu](http://www.campbellsci.eu) or by telephoning +44(0) 1509 828 888 (UK). You are responsible for conformance with governing codes and regulations, including safety regulations, and the integrity and location of structures or land to which towers, tripods, and any attachments are attached. Installation sites should be evaluated and approved by a qualified engineer. If questions or concerns arise regarding installation, use, or maintenance of tripods, towers, attachments, or electrical connections, consult with a licensed and qualified engineer or electrician.

## General

- Prior to performing site or installation work, obtain required approvals and permits. Comply with all governing structure-height regulations, such as those of the FAA in the USA.
- Use only qualified personnel for installation, use, and maintenance of tripods and towers, and any attachments to tripods and towers. The use of licensed and qualified contractors is highly recommended.
- Read all applicable instructions carefully and understand procedures thoroughly before beginning work.
- Wear a **hardhat** and **eye protection**, and take **other appropriate safety precautions** while working on or around tripods and towers.
- **Do not climb** tripods or towers at any time, and prohibit climbing by other persons. Take reasonable precautions to secure tripod and tower sites from trespassers.
- Use only manufacturer recommended parts, materials, and tools.

## Utility and Electrical

- **You can be killed** or sustain serious bodily injury if the tripod, tower, or attachments you are installing, constructing, using, or maintaining, or a tool, stake, or anchor, come in **contact with overhead or underground utility lines.**
- Maintain a distance of at least one-and-one-half times structure height, or 20 feet, or the distance required by applicable law, **whichever is greater**, between overhead utility lines and the structure (tripod, tower, attachments, or tools).
- Prior to performing site or installation work, inform all utility companies and have all underground utilities marked.
- Comply with all electrical codes. Electrical equipment and related grounding devices should be installed by a licensed and qualified electrician.

## Elevated Work and Weather

- Exercise extreme caution when performing elevated work.
- Use appropriate equipment and safety practices.
- During installation and maintenance, keep tower and tripod sites clear of un-trained or non-essential personnel. Take precautions to prevent elevated tools and objects from dropping.
- Do not perform any work in inclement weather, including wind, rain, snow, lightning, etc.

## Maintenance

- Periodically (at least yearly) check for wear and damage, including corrosion, stress cracks, frayed cables, loose cable clamps, cable tightness, etc. and take necessary corrective actions.
- Periodically (at least yearly) check electrical ground connections.

WHILE EVERY ATTEMPT IS MADE TO EMBODY THE HIGHEST DEGREE OF SAFETY IN ALL CAMPBELL SCIENTIFIC PRODUCTS, THE CUSTOMER ASSUMES ALL RISK FROM ANY INJURY RESULTING FROM IMPROPER INSTALLATION, USE, OR MAINTENANCE OF TRIPODS, TOWERS, OR ATTACHMENTS TO TRIPODS AND TOWERS SUCH AS SENSORS, CROSSARMS, ENCLOSURES, ANTENNAS, ETC.



# Table of Contents

---

PDF viewers: These page numbers refer to the printed version of this document. Use the PDF reader bookmarks tab for links to specific sections.

<b>1. Introduction .....</b>	<b>1</b>
<b>2. Specifications.....</b>	<b>2</b>
<b>3. Getting Started .....</b>	<b>3</b>
3.1 Factory Setup .....	3
3.2 Installing MultiMedia Player .....	4
3.3 ActiveX Controls in Internet Explorer.....	4
3.4 Setup Using Ethernet .....	4
3.4.1 Link Local IP Address Auto-Configuration.....	4
3.4.2 Static IP Address Setup.....	5
3.5 Setup Using Device Configuration Utility .....	8
<b>4. Cables/Wiring .....</b>	<b>10</b>
4.1 Power & I/O Cable Connections.....	10
4.2 Power & I/O Cable Details .....	12
4.3 Ethernet Cables .....	13
<b>5. Camera Hardware Description .....</b>	<b>13</b>
5.1 Ethernet RJ45 Connection .....	14
5.2 Power I/O Connection.....	14
5.3 Setup Button/Status LED .....	14
5.3.1 Status LED.....	15
5.3.2 Setup Button .....	15
5.4 SD Memory Card.....	16
5.4.1 Link for Most Recent Image and Video.....	16
5.4.2 Accessing SD Memory Card .....	17
5.4.3 FTP Image Collection from Memory Card.....	17
5.5 Switched Power Output .....	18
<b>6. Camera Configuration .....</b>	<b>18</b>
<b>7. Camera Operation using Web Browser Interface ..</b>	<b>19</b>
7.1 Live Video Homepage .....	20
7.2 Real Time Streaming Protocol (RTSP).....	21
7.3 Network Configuration .....	22
7.3.1 Network Settings.....	23
7.3.2 Ethernet Power Mode Settings.....	23
7.3.3 FTP Client Set-up .....	26
7.3.4 SMTP (Email) Server Settings.....	26
7.3.5 SNTP (TIME) Server Setting.....	28
7.4 System Configuration .....	28
7.4.1 System Date and Time.....	29
7.4.2 Automatic Date and Time Update .....	30

7.4.3	Site Name .....	31
7.4.4	Users and Security.....	31
7.4.5	Digital I/O Settings .....	32
7.4.5.1	External Trigger Input Settings .....	33
7.4.5.2	Light Power Control Settings .....	33
7.4.5.3	Communication Power Control .....	33
7.4.5.4	Heater Power Control .....	34
7.4.6	Update .....	34
7.4.7	Events.....	35
7.4.8	Save/Read Camera Settings .....	35
7.5	Memory Card .....	36
7.6	Video Settings .....	39
7.6.1	GPS Coordinates .....	41
7.6.1.1	Example Program – Adding GPS Coordinates to the Image Banner.....	41
7.7	Image Capture .....	42
7.7.1	Power Modes.....	43
7.7.2	Self-Timed Capture1 .....	46
7.7.3	Self-Timed Capture2 .....	51
7.7.4	External Trigger .....	51
7.7.4.1	File Transfer Queuing.....	51
7.7.4.2	External Trigger Video Pre-Recording.....	51
7.7.5	Motion Detection .....	55
7.7.5.1	CC5MPX Motion Detection Description .....	55
7.7.5.2	Motion Detection Video Pre-Recording .....	56
7.7.6	Save/Read Camera Settings .....	60
7.8	PakBus Communication Settings .....	60
7.9	Still Images.....	61
7.9.1	GPS Coordinates [AL: exactly the same as 7.6.1] .....	64
7.9.1.1	Example Program – Adding GPS Coordinates to Image Banner.....	64
<b>8.</b>	<b>Internal Jumpers .....</b>	<b>65</b>
8.1	RS-232/RS-485 Jumpers .....	65
8.2	External Trigger Pull-up/Pull-down Jumper .....	65
<b>9.</b>	<b>RS-232 Communications .....</b>	<b>66</b>
<b>10.</b>	<b>RS-485 Communications .....</b>	<b>68</b>
<b>11.</b>	<b>PakBus Communications .....</b>	<b>69</b>
11.1	Concurrent PakBus Communications.....	69
11.2	PakBus Graph Operations .....	70
11.2.1	Logger Settings .....	70
11.2.2	Discovery .....	70
11.2.3	Power Modes.....	70
11.3	PakBus Variable Control.....	70
11.3.1	PakBus Control of Window Defroster Function .....	71
11.3.2	PakBus Control of CC5MPX Power .....	71
11.3.3	Example Program – SendVariable Instruction .....	71
11.4	PakBus Neighbouring Address.....	72
<b>12.</b>	<b>Device Configuration Utility .....</b>	<b>72</b>



<b>13. Image Quality .....</b>	<b>74</b>
13.1 Night Time Images.....	74
<b>14. Lens .....</b>	<b>74</b>
14.1 Camera Lens and Field of View.....	76
14.2 Focus and Zoom Adjustment .....	76
14.2.1 Using the Focusing Number .....	77
14.3 Temperature Variations and Focus .....	78
14.4 Lens IR Cut Filter .....	78
<b>15. Power Calculations and Timings .....</b>	<b>78</b>
15.1 Standalone Operation.....	78
15.2 Operation with Communications .....	79
<b>16. Campbell Datalogger Interface Guide.....</b>	<b>81</b>
16.1 Datalogger Memory Setup .....	81
16.2 Datalogger Files Manager.....	81
16.3 Datalogger COM Port (Control Port) Communications.....	82
<b>17. Remote Image Retrieval.....</b>	<b>83</b>
17.1 LoggerNet File Retrieval .....	83
17.2 Using LoggerNet File Control .....	84
<b>18. Installation .....</b>	<b>85</b>
<b>19. Maintenance .....</b>	<b>87</b>
19.1 Lithium Battery .....	87
19.2 Window and Lens Cleaning .....	88
19.3 CC5MPX O-Rings .....	88
19.4 CC5MPX Desiccant.....	89
<b>20. Backplate Removal Procedures.....</b>	<b>90</b>
<b>21. System Limitations .....</b>	<b>91</b>
21.1 High Resolution 5 Megapixel Images.....	91
21.2 Simultaneous Processes .....	91
<b>22. Internal USB Function .....</b>	<b>91</b>
<b>23. Quick Notes .....</b>	<b>93</b>
23.1 CC5MPX General.....	93
23.2 Campbell Dataloggers Users.....	94
23.3 Configuration Process.....	94
<b>Appendix A. CC5MPX Series Cameras and Accessories.....</b>	<b>A-1</b>

A.1	CC5MPXWD .....	A-1
A.2	CC5MPX with Zoom Lens.....	A-1
A.3	CC5MPXFE .....	A-1
A.4	Window Defroster .....	A-1
A.5	Power & I/O Cable .....	A-1
A.6	Environmental Ethernet Cable .....	A-2
A.7	L18549 Mounting Kit.....	A-3
A.8	C2469 DB9 FEMALE To Terminal Block Adaptor .....	A-4
A.9	C2641 Desiccant .....	A-4

## **Appendix B. Window Defroster Option Specifications (Parts C2670 or C2681)..... B-1**

B.1	Power Supply .....	B-1
B.2	Description .....	B-1

## **Figures**

Figure 1-1	CC5MPX Camera.....	1
Figure 3-1	Network and Sharing Center .....	5
Figure 3-2	Local Area Connection Properties.....	6
Figure 3-3	Internet Protocol Version 4 (TCP/IPv4) Properties .....	6
Figure 3-4	IP Address Configuration .....	7
Figure 3-5	Web Interface Live Video Home Page.....	8
Figure 3-6	CC5MPX shown in Device Configuration Utility.....	9
Figure 3-7	CC5MPX Device Configuration Utility Settings Editor .....	9
Figure 4-1	CC5MPX Connector Layout .....	12
Figure 5-1	CC5MPX Connector Layout .....	13
Figure 5-2	Image Collection from Installed SD card.....	18
Figure 7-1	CC5MPX Web Interface Homepage .....	19
Figure 7-2	Live Video (Homepage).....	20
Figure 7-3	Network Configuration Warning.....	22
Figure 7-4	Network Configuration Page.....	22
Figure 7-5	Network Settings .....	23
Figure 7-6	Ethernet Power Savings Settings.....	24
Figure 7-7	FTP Server Settings.....	26
Figure 7-8	SMTP Server Settings .....	27
Figure 7-9	SNTP Server Settings .....	28
Figure 7-10	System Settings .....	29
Figure 7-11	Date and Time Settings .....	30
Figure 7-12	Automatic Date and Time Update .....	30
Figure 7-13	Site Name .....	31
Figure 7-14	Location of Site Name.....	31
Figure 7-15	Users and Security Settings.....	32
Figure 7-16	Digital I/O Settings.....	33
Figure 7-17	Update Menu .....	34
Figure 7-18	Event Logs.....	35
Figure 7-19	Save/Read Camera Settings.....	36
Figure 7-20	Memory Card Page.....	36
Figure 7-21	Memory Card Directory Listing .....	37
Figure 7-22	Data Subfolders .....	38
Figure 7-23	Example Display of Files .....	38
Figure 7-24	Example of Multiple Page Viewing .....	39
Figure 7-25	Video Settings Page.....	39
Figure 7-26	Video Banner Inside Top with Timestamp and Text.....	40
Figure 7-27	Image Capture Page.....	42

Figure 7-28 Power Modes.....	43
Figure 7-29 Self-Timed Capture Page .....	46
Figure 7-30 Enable and Capture Time Values.....	47
Figure 7-31 External Trigger Setup Page .....	52
Figure 7-32 Motion Detection Page.....	55
Figure 7-33 Save/Read Camera Settings .....	60
Figure 7-34 Communication Settings Page .....	60
Figure 7-35 Still Images Settings Page.....	62
Figure 8-1 Internal Jumper Locations.....	65
Figure 8-2 Schematic Showing External Contact Device.....	66
Figure 9-1 Serial PakBus Port Setting .....	67
Figure 9-2 Connecting the CC5MPX to a 9 Pin RS-232.....	67
Figure 9-3 Datalogger Connections with RS-232.....	68
Figure 10-1 RS-485 Shown in PakBus Port Setting .....	69
Figure 12-1 CC5MPX Device Configuration Option .....	73
Figure 12-2 Device Configuration Utility Screen.....	74
Figure 14-1 CC5MPX Lens Tube Removal .....	75
Figure 14-2 Zoom and Focus Adjustments.....	75
Figure 14-3 CC5MPX Horizontal Field of View.....	76
Figure 14-4 Field of View - Fisheye Lens .....	76
Figure 14-5 Homepage Video Display and Focusing Numbers .....	78
Figure 17-1 File Retrieval Setup Screen .....	83
Figure 17-2 Loggernet Connection Screen .....	85
Figure 17-3 USB Drive View in File Control.....	85
Figure 18-1 CC5MPX Mounting Kit.....	86
Figure 18-2 CC5MPX Mounting Holes.....	86
Figure 18-3 CC5MPX Mounted to Crossarm.....	87
Figure 19-1 Backplate O-ring .....	88
Figure 19-2 Button Cap O-ring.....	88
Figure 19-3 Front Main Body O-ring .....	89
Figure 19-4 Desiccant Location.....	90
Figure 20-1 Backplate View .....	91
Figure 22-1 USB Network Interface.....	92
Figure 22-2 CC5MPX USB Directory.....	92
Figure 22-3 Network Configurations.....	93

## **Tables**

Table 3-1 CC5MPX Default Configuration .....	3
Table 4-1 Power & I/O Cable Color Connections .....	10
Table 4-2 Power & I/O Cable Wire Usage .....	11
Table 5-1 Setup Button LED Indicator .....	15
Table 7-1 Network Settings .....	23
Table 7-2 Ethernet Power Save Modes .....	24
Table 7-3 Typical Video File Sizes.....	41
Table 7-4 Power Modes .....	44
Table 7-5 Capture Response Time .....	45
Table 7-6 Start and Stop Time Examples.....	48
Table 7-7 Self-Time Capture Variables .....	49
Table 7-8 External Trigger Variables.....	52
Table 7-9 Motion Detection Settings .....	57
Table 7-10 PakBus Communication Settings.....	61
Table 7-11 Still Image Settings.....	62
Table 7-12 Still Image Resolution Details .....	63
Table 15-1 Power Consumption (Standalone) .....	79
Table 15-2 File Transfer Times Using PakBus .....	80
Table 23-1 Power Mode Summary .....	95

# CC5MPX Digital Camera

---

## 1. Introduction



**Figure 1-1 CC5MPX Camera**

The CC5MPX Series digital network cameras are designed to meet the stringent operational requirements necessary for remote battery powered installations while producing images of up to 5 megapixels. Both cameras can operate over a wide temperature range and have several advanced power saving modes to suit a variety of needs.

---

**Note**

CC5MPX will be used to refer to the series throughout the manual, unless otherwise specified.

---

The CC5MPX incorporates an integrated rugged environmental enclosure to reduce cost and installation time. Communication options include Ethernet, RS-232, and RS-485. The CC5MPX is fully web-enabled with FTP and Email capabilities. Campbell Scientific's PakBus protocol is supported by the CC5MPX for integration with Campbell Scientific dataloggers. When required, an optional lens defroster is available.

The camera contains an onboard SD memory card that can turn the camera into a powerful image and video logger. The onboard memory card enables the CC5MPX to archive images and video internally.

The CC5MPX can operate in a stand-alone mode with image acquisitions triggered by the camera's own precision real time clock. Image and video acquisitions can also be triggered by events through an external signal or motion detection.

## 2. Specifications

### Power Supply

**Operating:** 9-30 VDC 250 mA Maximum (Camera only)  
9-16 VDC 1.0 A Max @ 12 VDC (Camera w/ Defroster Option)\*

**Quiescent:** 1 mA Maximum (Off power mode)

### Note

**\*Warning: The CC5MPX is specified to operate on a 9-30 VDC supply input range. When the window defroster is installed, the 30 VDC maximum must be reduced to 16 VDC. Operating the CC5MPX with window defroster at voltages greater than 16 VDC can cause damage to the CC5MPX.**

### Operating

**temperature** -40°C to +60°C

**Clock Accuracy** ± 2 Minutes/Year (-40°C to +60°C)

### Lens

Mount: C-Type  
IRIS: DC Compatible  
Standard lens: 4-12 mm, 27° to 80° field of view  
Zoom lens: 10-40 mm, 9° to 35° field of view  
Fisheye lens: 1.4-3.1 mm, 94° to 185° field of view

### Image or Video Capture Triggers:

Two independent self-timers  
Motion detection  
Web page control  
External trigger

### Still Image Resolution (JPEG)

2592x1944	640x352
1280x960	320x240
1280x720	320x176
640x480	

**Video** Capable of 720P – 1280x720 (MPEG4)  
640x480 (Live Video Only/MJPEG), 320x240 (MPEG4)

### Ext. Input Signal

Logic Low Level: < 0.65 V (-20 VDC Absolute Min)  
Logic High Level: > 2.0 VDC (+20 VDC Absolute Max)  
Minimum Pulse Width: 10 ms

### Communication Interfaces

Ethernet 10/100  
RS-232 port  
RS 485 port

### Communication Protocols

Webpage interface via web browser  
FTP  
Email  
PakBus (for Campbell Dataloggers)

**Communication Switched Power Output**

Maximum Output Current: 750 mA

**RS-232 and RS 485**

Max. BAUD rate: 115.2 KBAUD

---

**Note** The recommended maximum cable length at this BAUD rate is 15 meters. The use of the 57.6 KBAUD rate has a recommended maximum cable length of 30 meters.

---

**Memory Card Interface**

Type: Secure Digital (SD)

File System: FAT32

File Type: JPEG (image), AVI (video)

Size: Verified up to 16 GB

**Dimensions**

Length: 220 mm (8.7"), 229 mm (9.0") w/ zoom lens

Width: 93 mm (3.7")

Weight: 1.06 kg (2.34 lbs.)

## 3. Getting Started

Ensure that the pigtail end of the power cable is properly terminated (see Wiring, Section 4) before connecting the power cable connector to the camera. If the power supply has an on/off switch it is also recommended to switch the power off before connecting the power connector to the camera.

For the initial power up and set up of the camera, it is useful to unscrew the protective cap that protects the push button and LED indicator.

### 3.1 Factory Setup

The following table outlines some of the CC5MPX settings that are relevant for initially communicating with the CC5MPX camera:

<b>Configuration Setting</b>	<b>Value</b>
Power Mode	Fully on
Link Local IP	169.254.99.99
Network IP Address	192.168.1.90 (Static)
Network Mask	255.255.255.0
Serial I/O Port	RS-232
RS-232 Baud Rate	115200
PakBus Address	55

There are two different ways to set up the parameters in the CC5MPX. The Ethernet network interface can be used with a web browser or the RS-232 serial lines can be used with Campbell Scientific's Device Configuration utility. The use of RS-232 serial lines will require the use of the DB9 terminal block adapter in order to connect to a PC (Section 4, Table 4-1).

When power is first applied to the camera the LED will turn on and remain steadily on for about 90 seconds. Once the LED starts flashing the camera has initialized properly and is ready for operation.

## 3.2 Installing MultiMedia Player

The use of a MultiMedia player is required on your computer to properly display the video from the CC5MPX. We recommend the use of the VideoLAN VLC media player, which is a free, open-source software, which ensures that the proper video codecs are available on your computer. The download is available online at:

<http://www.videolan.org/vlc/>

Download and install the appropriate VLC media player to the PC that will be interfacing with the CC5MPX.

## 3.3 ActiveX Controls in Internet Explorer

Currently the CC5MPX is only fully supported using the Windows Internet Explorer (32 bit) browser.

The web interface for the CC5MPX requires the use of ActiveX controls when using Internet Explorer. These add-ons allow Windows to interact with objects in the web interface through Internet Explorer.

When connecting to the CC5MPX via the web interface for the first time, you should be prompted to run the ActiveX add-ons. The prompt is in the form of a 'pop-up' in Internet Explorer and should be allowed.

## 3.4 Setup Using Ethernet

### 3.4.1 Link Local IP Address Auto-Configuration

The CC5MPX supports an automatic IP address configuration in situations where the camera is directly connected, via Ethernet cable, to a computer without the need of a DHCP server.

This feature is automatically enabled in the camera and is transparent to its normal operation. In this situation the camera will be accessible using the IP address 169.254.99.99. This address will be valid for accessing the camera in any network configuration.

---

**Note**

In order to use Link Local the computer connecting to the CC5MPX must be configured to use DHCP. If the computer is configured to use a static IP one of the remaining interface arrangements will need to be used.

---



### 3.4.2 Static IP Address Setup

If your computer is not set to use DHCP to obtain an IP address automatically, you will need to follow the procedure outlined in this section to access the camera's webpage. It may be beneficial to speak with someone in your IT department if you are not familiar with configuring devices for operation on a network.

The default static IP address for the camera is 192.168.1.90. If the standard assigned static IP address is compatible with your current network, you may simply plug the camera into the network and access the web page using this IP. If this IP address is not compatible with your network, then you will have to connect the camera directly to your computer's Ethernet port in order to change its IP address.

The easiest way to connect to the CC5MPX to change its IP address settings, is to manually configure your computer's Ethernet IP address to be compatible with the default address assigned to the CC5MPX.

In order to make these changes to your computer's network settings, you will need to have Administrator access. The procedure for changing these network settings in Windows 7 is explained below:

Connect the CC5MPX camera directly to your computer's Ethernet port. You can use either a standard Ethernet cable or a crossover Ethernet cable, as the CC5MPX's auto-MDIX feature allows the camera to automatically connect using either cable.

Open the *Control Panel*. If you are in Icon view, click *Network and Sharing Center*. If you are in Category view, click *Network and Internet*, then click *Network and Sharing Center*.

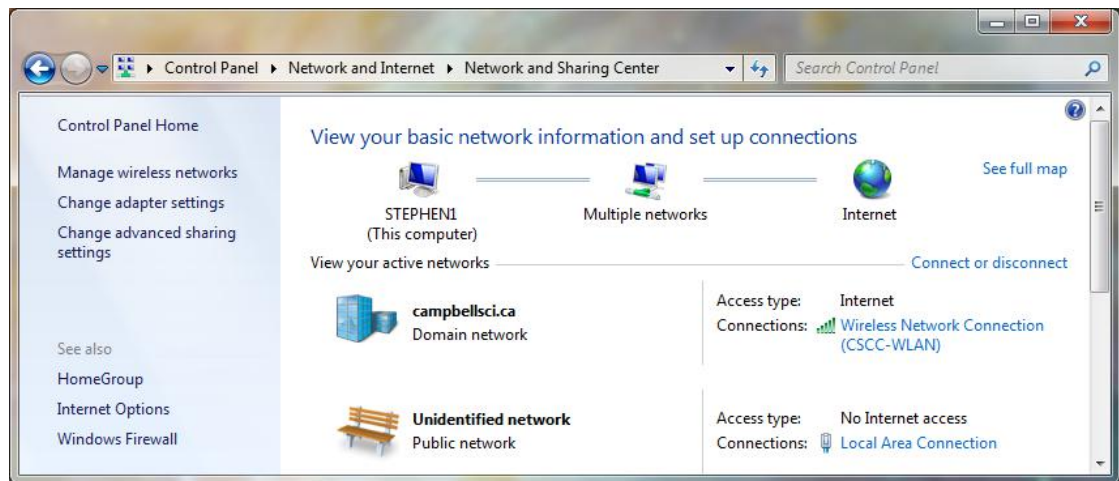
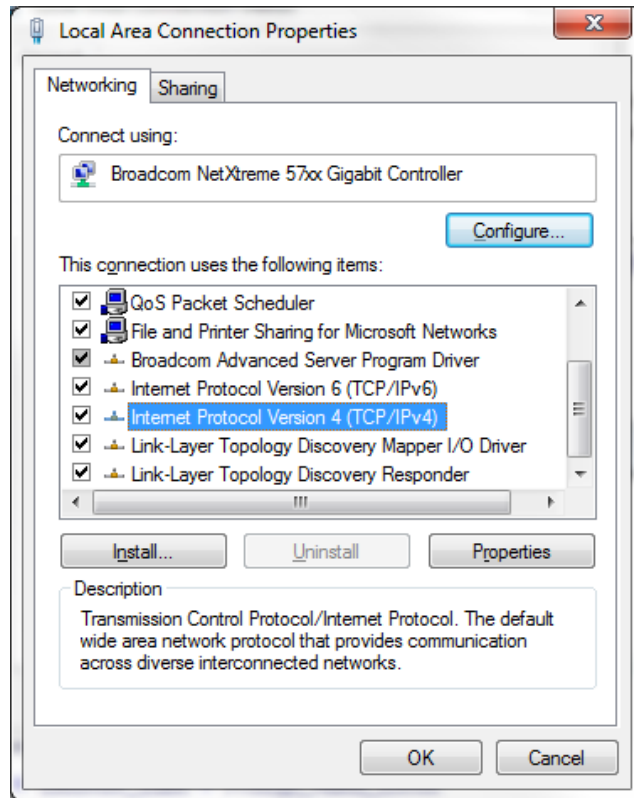

Figure 3-1 Network and Sharing Center

Under Connections on the right-hand-side, click *Local Area Connection*, then select *Properties*.



**Figure 3-2 Local Area Connection Properties**

Click on *Internet Protocol Version 4 (TCP/IPv4)*, then select *Properties*.

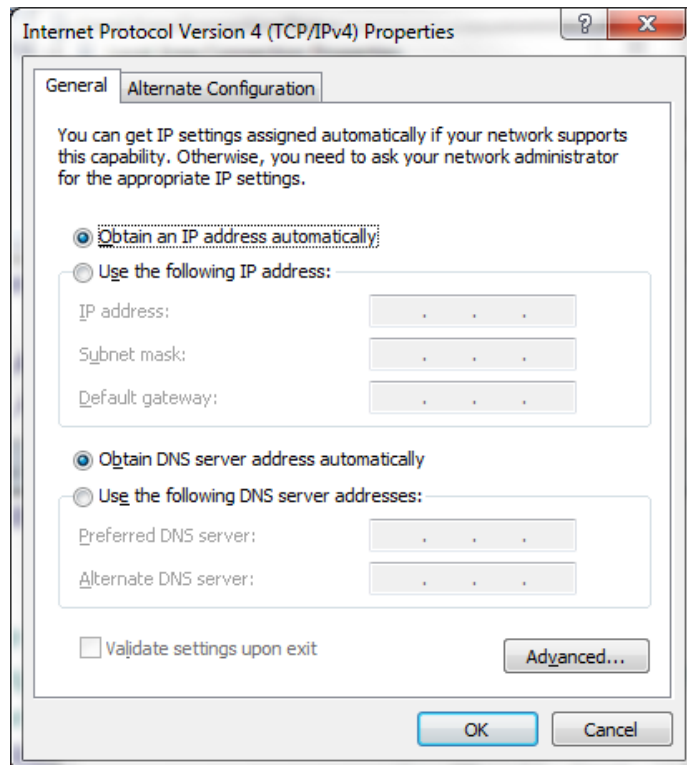
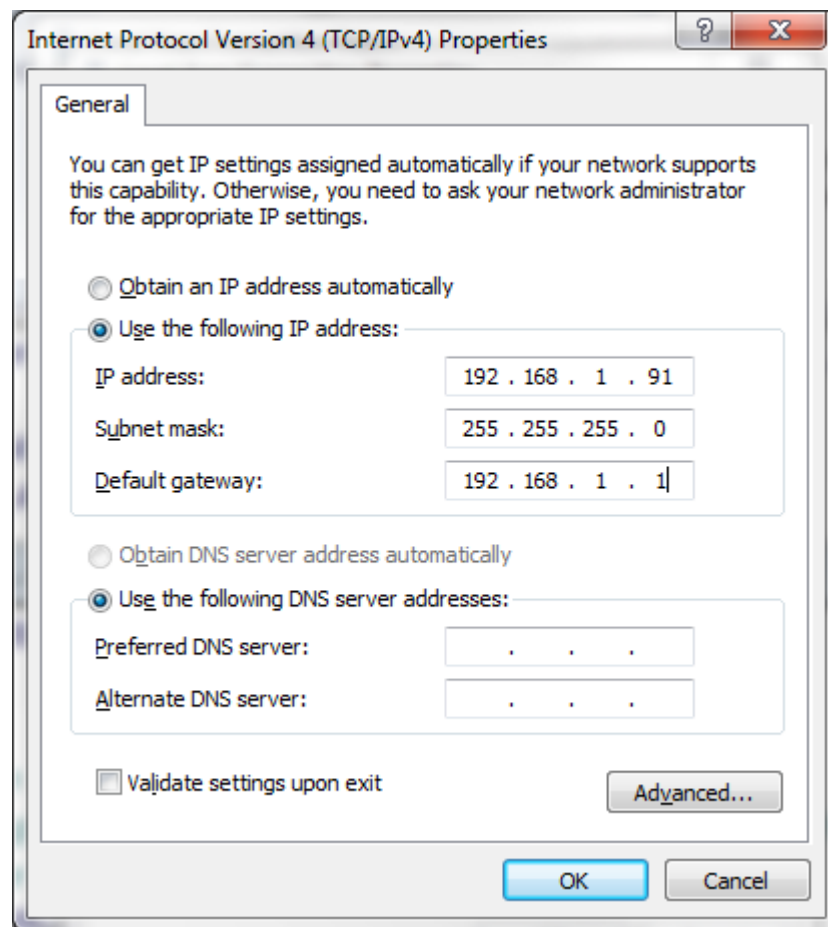

**Figure 3-3 Internet Protocol Version 4 (TCP/IPv4) Properties**

You should record existing settings that are used on the computer to restore the connection once the CC5MPX setup is complete. In Figure 3-3, the computer is set to obtain the IP address automatically.

Click *Use the following IP address* and enter the following values:

- IP address: 192.168.1.91
- Subnet mask: 255.255.255.0
- Default gateway: 192.168.1.1



**Figure 3-4 IP Address Configuration**

Click OK to accept. This may prompt a *Microsoft TCP/IP* Warning pop-up. If you see this pop-up, click *Yes*.

You should now be able to open Internet Explorer and access the camera by typing <http://192.168.1.90> or clicking this link. Once the computer establishes a connection the following page should be displayed in your browser:

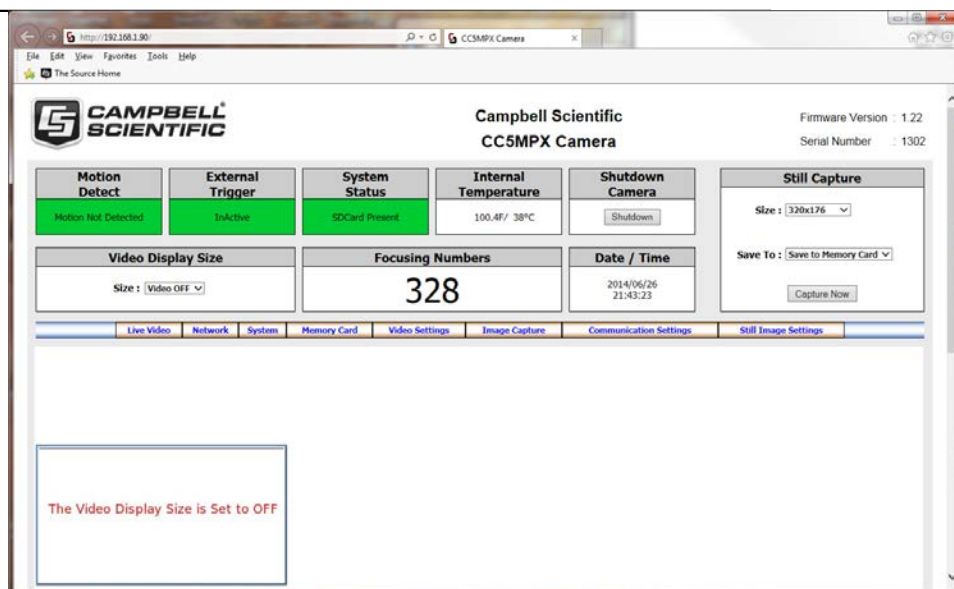

**Figure 3-5 Web Interface Live Video Home Page**

If you select a video format to display from the *Video Display Size* dropdown box, you should be prompted to install or allow an ActiveX control. By default, your browser may be configured to block pop-ups. You will need to enable the pop-up for the camera.

Now that a connection has been established, please see Section 7.3 for further instructions on how to change the camera's network settings.

After the changes have been completed, remember to re-enter your computer's original IP address settings in the *Internet Protocol Version 4 (TCP/IPv4) Properties* window.

### 3.5 Setup Using Device Configuration Utility

Campbell Scientific provides a free software program called *Device Configuration Utility* that supports the configuration of a variety of equipment. The CC5MPX can also be configured with the *Device Configuration Utility*. Please visit the Campbell Scientific website to ensure that you have the most recent version of this utility.

The CC5MPX ships from the factory with the communication lines configured for the RS-232. The Green wire on the cable is the CC5MPX RS-232 TX (output) line, the White wire is the CC5MPX RS-232 RX (input) line. A connection will also need to be made from the CC5MPX Black Ground to the RS-232 Ground.

The CC5MPX comes with a Female DB9 to Terminal block accessory that facilitates the connection from the **Power & I/O Cable** to a 9 pin RS-232 connector. See Section 4 for wiring details.

When power is first applied to the camera the LED will turn on and remain steadily on for about 90 secs. Once the LED starts flashing, the camera has initialized properly and is ready for operation.

The Device Configuration Utility can now be invoked. Select the CC5MPX as the device type and the appropriate COM port.

Once the appropriate selections are made, select the connect button.



Figure 3-6 CC5MPX shown in Device Configuration Utility

The camera has a large number of variable information so it may take about 30 secs for this process to be complete. Once the settings are loaded, clicking the tabs located near the top of the page will allow navigation to the various settings.

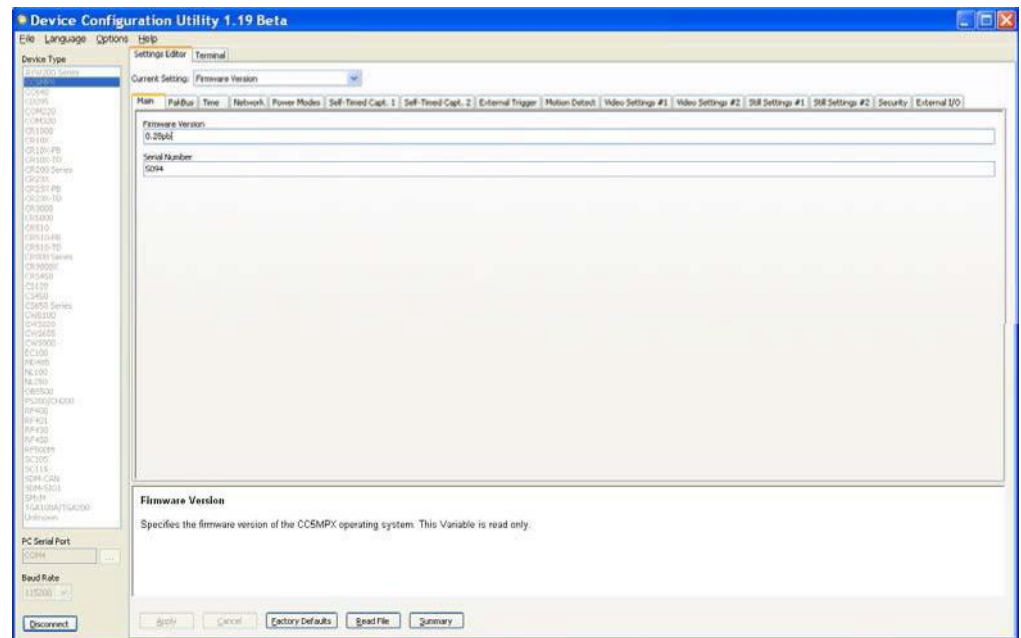

Figure 3-7 CC5MPX Device Configuration Utility Settings Editor

## 4. Cables/Wiring

### 4.1 Power & I/O Cable Connections

The wiring for the **Power & I/O Cable** connector assemble is as shown in Table 4-1. The wires can be terminated directly on the control ports of a compatible datalogger.

**Note**

It is essential that the Ground cable be connected first when wiring the camera to the datalogger or the power supply

<b>Table 4-1 Power &amp; I/O Cable Color Connections</b>		
<b>Color</b>	<b>Function</b>	<b>Connection</b>
Black	Power Ground	System Ground
Red	Input Power	Power Source 9-30 VDC
Green	RS-232 TX (output)	RS-232 Input (RX control port of datalogger or Pin 2 of a computer (DTE) DB-9 Connector)  RS-485A when configured to RS-485
White	RS-232 RX (input)	RS-232 Output (TX control port of a datalogger or Pin 3 of a computer (DTE) DB-9 connector)  RS-485B when configured to RS-485
Yellow	Communication Switched Power (Output)	This line is intended to power a communication device. The camera switches the Input power voltage to this line
Blue	External Trigger (Input)	Connect to external signal source (i.e. datalogger control port). The external signal wakes up or initiates image/video acquisition
Clear	Shield	Shield/Earth Ground

Refer to Section 8, Internal Jumpers if the current RS-232 or RS-485 interface option needs to be changed in the camera.

Refer to Table 4-2 to help determine which wires will need to be connected for your camera application.

<b>Table 4-2 Power &amp; I/O Cable Wire Usage</b>			
<b>Wire Color</b>	<b>Function</b>	<b>Connection Required</b>	<b>When not Used</b>
<b>Black</b>	Power Ground	<b>Always</b>	
<b>Red</b>	Input Power	<b>Always</b>	
<b>Green</b>	RS-232 TX (output) OR RS-484A	The Green wire only needs to be connected when RS-232 or RS-485 communications are used for PakBus or the Device Configuration Utility.	Connect to a grey terminal block
<b>White</b>	RS-232 RX (input) OR RS-485B	The White wire only needs to be connected when RS-232 or RS-485 communications are used for PakBus or the Device Configuration Utility.	Connect to a grey terminal block
<b>Yellow</b>	Communication switched power (output)	When the camera is being used to manage power to a communication modem.  For solar powered sites the camera can remove power from the modem when communications are not required.	Connect to a grey terminal block
<b>Blue</b>	External trigger (input)	When another device is being used to trigger the camera to capture images or video. This can be a datalogger, a motion sensor, or a set of contacts.  Another device can also help keep the camera in the Fully On Power mode by leaving the External Trigger Input asserted.	Connect to ground if left in Factory Default settings
<b>Clear</b>	Shield	<b>Always</b>	

## 4.2 Power & I/O Cable Details

The Power & I/O cable that is used for the CC5MPX camera has an outdoor environmentally rated screw type connector on one end and discrete wire pigtails on the other end that allow for flexible termination. When making the cable connection to the camera the notch positions should always be lined up and care should be taken to not cross the connector.

For information about the cable options available, see Appendix A.

- 24-AWG 3 pair (6 conductor) Individually Shielded Cables with Santoprene Jacket
- IP-67 rated connector
- 10 inch pigtail for termination
- 3 Single Pole 16-20AWG Grey Push Operated Connector Terminals (Figure 4-1)
- Maximum recommended cable length is 20 m (100 feet)

Longer cable lengths can be used; however, a heavier gauge of wire is suggested. It is recommended that the individual wire resistance on the +12VDC and Ground conductors not exceed 2.7 Ohms. Using longer cable in conjunction with RS-232 communications will require slower BAUD rates. Depending on the cable length and type of cable, RS-232 may not be suitable for communications and the use of RS-485 should be considered.



**Figure 4-1 CC5MPX Connector Layout**



## 4.3 Ethernet Cables

The Ethernet connection is used to configure the camera settings as well as for targeting and focusing the camera. The Ethernet port of the CC5MPX is auto MDIX; therefore, an Ethernet crossover cable is not required when connecting the camera to other devices.

A standard CAT5 (or better) Ethernet cable with RJ45 connectors can be used to interface to the camera in indoor conditions or for temporary connection outdoors when conditions permit. When an Ethernet connection is required for permanent outdoor installations or when a connection to the camera is required in wet or harsh conditions, the Environmental Ethernet Cable assembly needs to be used.

The Environmental Ethernet Cable assembly provides one end with an environmental connector that provides a weather proof connection when properly mated to the camera. The other end of the cable consists of a standard RJ45 connector. Environmental Ethernet Cable is meant to provide an Ethernet connection between the CC5MPX and a network router, cellular modem, or laptop.

Details of the Environmental Ethernet Cable are as follows:

- CAT5E Shielded cable with polyurethane jacket.
- IP67 environmentally rated RJ45 connector on one end and a regular RJ45 connector on the second end.
- Maximum recommended cable length 70 m (230 feet)

## 5. Camera Hardware Description



Figure 5-1 CC5MPX Connector Layout

## 5.1 Ethernet RJ45 Connection

The RJ45 connector on the camera is meant to interface the CC5MPX with either a network router, cellular modem, or directly to a laptop.

If a permanent Ethernet connection is not required for an outdoor environment, then the protective cap must be securely attached to the Ethernet connector to provide an environmental seal.

When the protective cap is removed a standard cable with an RJ45 connector can be used to connect the camera to another device in an indoor environment or temporarily outdoors if weather permits.

If a permanent Ethernet connection is required outdoors or if a connection is required in wet or harsh locations, the Environmentally Rated Ethernet Cable must be used.

The maximum cable length for the Ethernet cable is 70 m (230 feet).

---

**Note**

The CC5MPX does not support the PakBus communication protocol over Ethernet.

---

## 5.2 Power I/O Connection

Connection to the Power I/O connector is necessary for camera operation and it is the only means to supply power to the camera. The connector that connects to the Power I/O connector provides a weather tight connection and has an IP67 environmental rating when properly connected.

When making the cable connection to the camera the notch positions should always be lined up and care should be taken to not cross thread the connector.

## 5.3 Setup Button/Status LED

The Setup button is located behind a protective metal cap on the camera. The Setup button also contains an integrated Status LED for user feedback.

To access the LED, unscrew the protective cap to expose the Button/LED. It is highly recommended to place the protective cap back on for improved environmental protection.

### 5.3.1 Status LED

The Status LED located in the center of the button provides some useful diagnostic information about the camera. Table 5-1 describes the LED behavior.

<b>Table 5-1 Setup Button LED Indicator</b>		
<b>LED</b>	<b>CC5MPX State</b>	<b>Other</b>
Continuously Off	No power or the camera is in one of the following Low Powered Modes: <ul style="list-style-type: none"> <li>• Partially On</li> <li>• Deep Sleep</li> <li>• Off Mode</li> </ul>	Pressing the Setup Button will force the camera to exit any of the low powered modes and remain Fully on for a period of 5 min with the LED rapidly flashing
Slow Flash 1 sec on, 3 sec off	Normal Operation in Fully On Power mode	
Rapid Flash	Exit from low power state. The camera is being kept on by: <ul style="list-style-type: none"> <li>• Timeout (from the Setup Button press)</li> <li>• Communications</li> <li>• Asserted External Trigger</li> <li>• Image or video acquisition</li> </ul>	
Continuously On	The camera is booting up. The booting up process takes approximately 90 sec.	The camera will be required to boot up whenever: <ul style="list-style-type: none"> <li>• Power is first applied to it</li> <li>• The camera is exiting the Off Power mode to perform an operation.</li> </ul>

### 5.3.2 Setup Button

The primary function of the Setup button is to wake the camera from any of the power saving modes that it may be in. Once the Setup button is pushed the CC5MPX enters a fully powered mode for 5 minutes. During this interval, you are able to access the camera via Ethernet or RS-232/485 and make any necessary configuration changes. If no communications occur during the 5 minute window, the camera will return to its configured power saving mode and continue normal operation.

The secondary function of the Setup button is to facilitate a power down procedure. If the button is held for a period of 10 seconds, the camera will completely shut down for a period of 10 minutes. During this interval you are able to remove power from the camera and avoid possible corruption of the memory card. This function is also available through the camera Web interface via the 'Shutdown Camera' button box.

## 5.4 SD Memory Card

The camera is internally equipped to use an SD memory card. An extended temperature memory card is available as an option for the CC5MPX.

If you choose to use your own memory card, it will need to be formatted with a PC using the FAT32 format.

Image files can be stored on the SD memory card as JPEG files and video files are stored as AVI files. Individual image and video files are uniquely named with a sequence number, or with a date and time stamp. The directory location will correspond to the camera configuration and the method of triggering (i.e. motion detection).

The use of the card for image and video storage is entirely configurable to fit the needs of a given application. Individual image or video capture can be configured to manage memory card files as either a fill & stop, or with a ring memory.

Access to the SD card requires removal of the camera backplate. Insertion or removal should only be done when power is removed. See Section 5.4.2 for more information on image and video retrieval from the SD card. It is generally recommended to delete older image files from the memory card after downloading them to a permanent storage location.

Once the contents of the memory card are read or downloaded, it is recommended to reformat the memory card (using FAT32) to delete the entire contents. The CC5MPX writes binary files to the memory card to facilitate file management. Deleting or editing the contents of the memory card manually outside of the camera will invalidate the binary files, causing image and video storage to function unpredictably.

### 5.4.1 Link for Most Recent Image and Video

There are also permanent links available in the CC5MPX webserver to download the most recently captured images or video files available on the SD card. Each capture method has its own link. These links redirect to the actual files on the SD card, which means for continuity that the downloaded filename will be the same as the filename on the SD card.

---

**Note**

The following are examples and the IP address will vary with the camera's network configuration.

---

- Self-Timed 1:
  - <http://192.168.1.90/stc1.jpg>
  - <http://192.168.1.90/stc1.avi>
- Self-Timed 2:
  - <http://192.168.1.90/stc2.jpg>
  - <http://192.168.1.90/stc2.avi>
- External Trigger:
  - <http://192.168.1.90/etc.jpg>
  - <http://192.168.1.90/etc.avi>

- Motion Detection:
  - o <http://192.168.1.90/mdc.jpg>
  - o <http://192.168.1.90/mdc.avi>

## 5.4.2 Accessing SD Memory Card

In order to access the SD memory card you will need to remove the backplate of the CC5MPX. Before starting this process remove the CC5MPX from any power supply and disconnect any attached cabling.

Refer to Section 20 for details on removing the camera backplate.

The SD memory card is located on the main circuit board and can be removed by first pressing the card into the housing until you hear a click. The card can now be pulled from the card housing.

In order to properly reinstall the card, place it into the housing and press in until you hear a click.

Once finished with the SD card, replace the backplate. First ensure the O-ring is still seated properly on the backplate. This is very important as the O-ring is required to properly seal the camera.

The backplate can only be seated in the orientation that aligns the flat surfaces of the backplate and the bottom of the camera body. This will also help align the screw holes. The six screws can now be threaded and hand tightened. Be sure the two plastic washers are located between the tether chains and the backplate.

## 5.4.3 FTP Image Collection from Memory Card

If the camera is setup to store images to the memory card, it may be necessary to collect all the images from the memory card. The web interface does provide a user friendly method of viewing and saving select files from the memory card. However, if it is desired to collect a large number of files from an entire folder then using the web interface is very cumbersome.

It is recommended to access the CC5MPX memory card using the FTP file transfer process. On most Windows machines this is easily done by typing: <ftp://192.168.1.90:85> into Windows Explorer, where '192.168.1.90' is the IP address of the camera and the ':85' is the port used for FTP access. The camera supports FTP access to the memory card on port 85 of the camera. This will require an Ethernet connection to the camera.

Clicking a directory such as SelfTimed1Still will begin the navigation into that directory. Whole directories or files can be saved just like any other Windows folder.

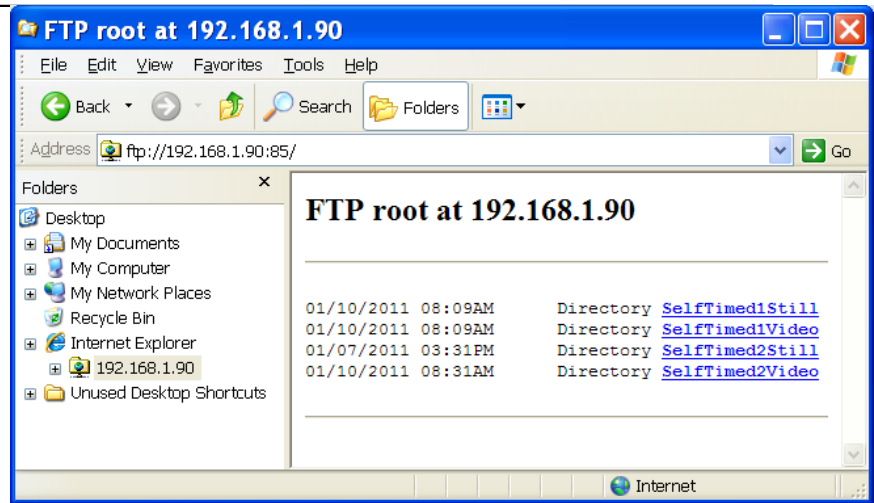

Figure 5-2 Image Collection from Installed SD card

## 5.5 Switched Power Output

The intended purpose of the switched power output is to control the power for a communication device. One common application is to have the camera control the power to a communication modem at a solar powered site. Refer to Section 7.3.5 for details on configuring the switched power output via the web interface.

This power management feature can greatly reduce the system power requirements by only turning on the modem when required to transmit an image or video. The switched power output will turn on under the following conditions:

- The camera in one of its low power modes and the Setup button is pressed. The camera will exit the low power mode and stay awake for 5 minutes with the switched power output on.
- A low power mode is selected and the camera wakes up from an event where communications are required. This will include FTP, SMTP (email), or PakBus transfers. Events requiring memory card storage only, will not turn on the switched power output as these events would not require a modem for communications.

## 6. Camera Configuration

There are 2 methods for a user to configure the CC5MPX camera.

The first is by using the web interface of the camera. This is the best way to set up the camera. Most users will need to communicate with the camera via the Ethernet connection in order to facilitate focusing and targeting of the camera when installed.

The other means of setting up the camera is by using the RS-232 serial lines on the Power I/O cable and using Campbell Scientific's Device Configuration software to change configuration parameters in the camera (Section 9). Device Configuration Utility is a free download from any Campbell Scientific website.

If you are not able to connect to the camera via the Local Area Connection due to a loss of configuration information, you will need to use the Device Configuration Utility.

A third method is available that involves opening up the camera to access the internal USB connector. Refer to Section 22 Internal USB Function for more details.

## 7. Camera Operation using Web Browser Interface

The web interface allows the user to:

- Fully configure the CC5MPX, as required.
- View information, system status, date, and time.
- View live video for the purpose of targeting and focusing the camera.

The CC5MPX supports an automatic IP address configuration in situations where the camera is directly connected via Ethernet cable to a computer. The camera is accessible using the IP address 169.254.99.99.

The camera ships with the default static IP address of 192.168.1.90 and a Network Mask of 255.255.255.0. It is highly recommended to keep track of any changes made to the network settings.

Refer to Section 3.4 Setup using Ethernet for details on making the initial network connection to the camera. To establish communications with the camera, use one of the methods previously discussed. Enter the appropriate IP address in the address bar of Internet Explorer. After typing the address, you should get the homepage of the CC5MPX camera, as shown in Figure 7-1.

Currently, only Windows Internet Explorer web browser is supported for use with the CC5MPX camera.

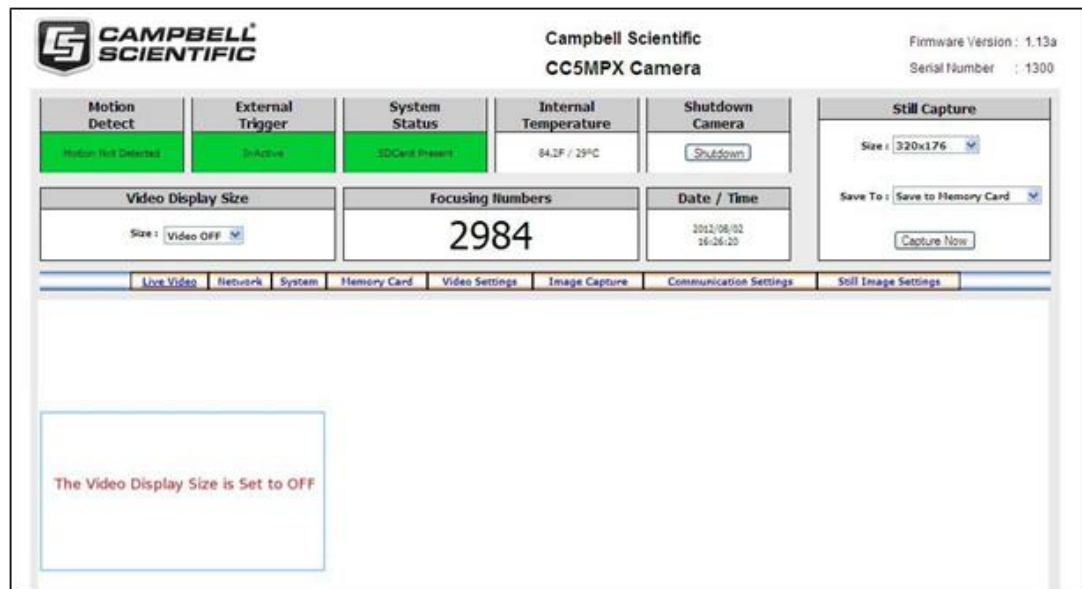

Figure 7-1 CC5MPX Web Interface Homepage

Some general items to remember about the web interface are:

- The homepage of the camera is the Live Video page. There are no operational settings to change on the Live Video page.
- If any settings are changed or added on any of the other pages, then the Submit button must be keyed to accept the changes. If the Submit button is not keyed, the changes will not be saved.

## 7.1 Live Video Homepage

The Live Video Homepage of the CC5MPX is shown in Figure 7-2.

Still Image Capture

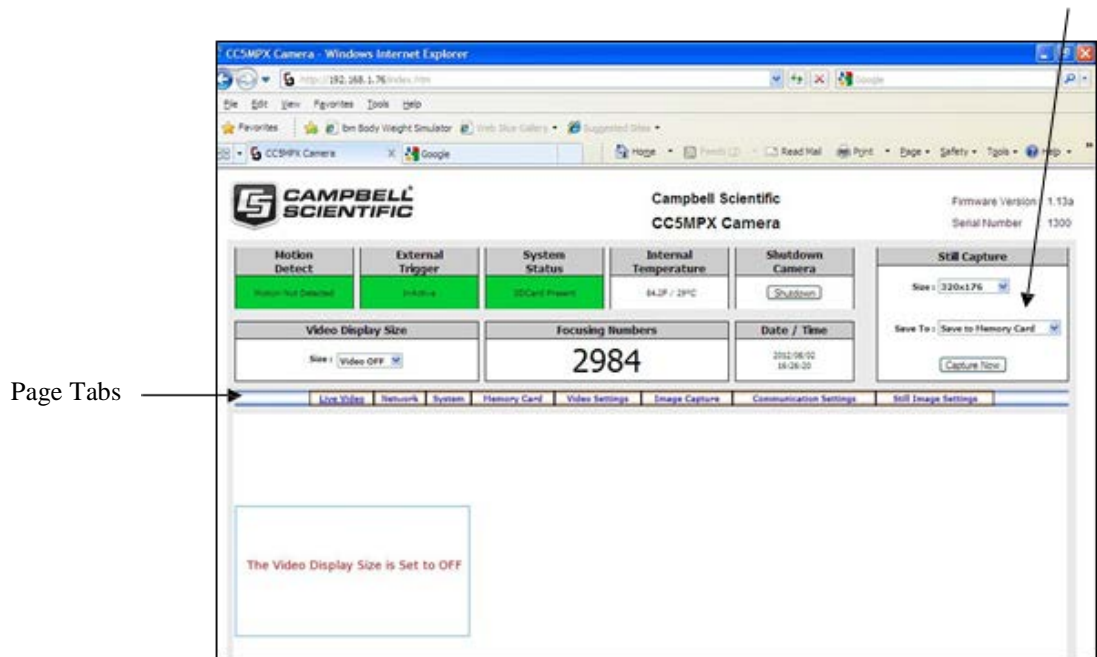

**Figure 7-2 Live Video (Homepage)**

The Homepage allows the user to manually capture still images or view real time video. The use of these features aids in the installation of the camera and testing the images.

When the Video Display Size is changed from Off to one of the video size settings, video should be displayed in the video display area. If you are not able to view video, review Section 3 Getting Started.

The Still capture box allows for the manual capture of Still Images. Select the desired size and method of capturing. The two methods of capturing include storing the image to the SD card in the directory ManualStill, or Save as File option, which enables the picture to be saved to the computer.

The 'Shutdown Camera' button provides a safe power down sequence. If at all possible, the Shutdown button should be used any time the power needs to be removed from a camera that is actively collecting and storing images or vidwo. It will completely shut down for a period of 10 minutes and ensure the memory card is not corrupted. An alternate way of shutting down the camera is to hold the Setup button down for at least 10 seconds.



Information features on the Live Video Homepage include:

- Motion Detection Indicator
  - o Turns from green to red when motion is detected
  - o This will indicate even if the motion capture is not enabled.
- External Trigger Status
  - o Reflects the state of the External Trigger signal on the Power I/O cable.
- System Status
  - o Indicates the SD card presence, absence or scanning. Note that the scan process can take several minutes to complete, and is invoked if the camera is shutdown by an unexpected reset or power removal.
  - o Displays system messages.
- Internal board temperature value
  - o When fully on, the internal temperature can be 10-15°C above ambient.
- Focusing numbers
  - o Facilitates focusing (see section Note: If the camera is targeted on an object that is far away (100 m or more), it may be beneficial to adjust the lens before taking the camera into the field by using an object that is at a similar distance away.
  - o 14.2.1 Using the Focusing Number).
- Date and Time.

The Live Video Homepage, as well as every other page, also contains a navigation bar with tabs that allow navigation to the other CC5MPX webpages. These are called Page Tabs.

---

**Note**

Any configuration changes made in the web interface must be 'submitted' to save and activate changes, or changes will be lost.

---

## 7.2 Real Time Streaming Protocol (RTSP)

Users can access the live video stream outside of our ActiveX control using RTSP. Only the 640x480 resolution is available. Note: if a user is viewing the RTSP video stream and another user tries viewing a different resolution using the camera webpage, the RTSP stream will stop.

The following sample code can be used to embed the video stream into a webpage. The IP address will need to be appropriately changed.

```
<OBJECT classid="clsid:9BE31822-FDAD-461B-AD51-BE1D1C159921"
codebase="http://downloads.videolan.org/pub/videolan/vlc/latest/win32/axvlc.cab"
width="640" height="480" id="vlc" events="True">
<param name="Src" value="http://192.168.1.90/ipcam/mjpeg.cgi" />
<param name="ShowDisplay" value="True" />
<param name="AutoLoop" value="False" />
<param name="AutoPlay" value="True" />
<embed id="vlcEmb" type="application/x-google-vlc-plugin"
version="VideoLAN.VLCPlugin.2"
autoplay="yes" loop="no" width="640" height="480"
target="http://192.168.1.90/ipcam/mjpeg.cgi" ></embed>
</OBJECT>
sic
```

## 7.3 Network Configuration

To access the main Network Configuration page, simply click the Network page tab.

When you first enter the Network page, you will receive the following prompt as a warning (see Figure 7-3). If changes are made to the camera that affects the access to the web interface you will need to restart the browser with the new configuration.

For example, if you change the IP address of the camera, the changes will be accepted by clicking on the submit button; the new IP address will be in effect.

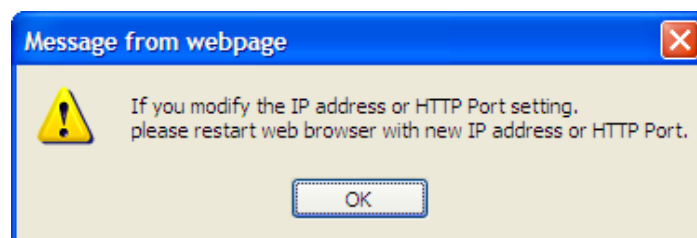

Figure 7-3 Network Configuration Warning

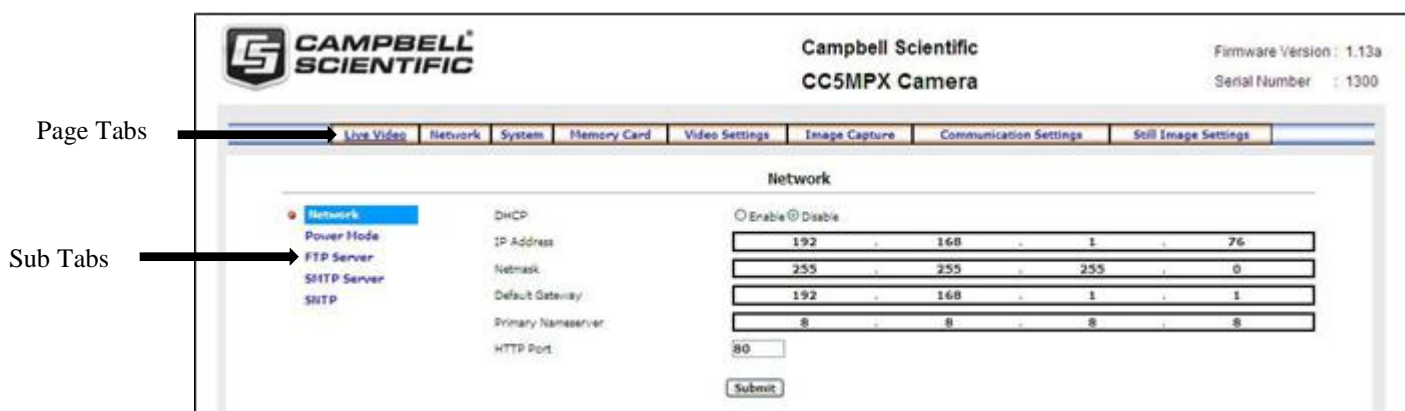

Figure 7-4 Network Configuration Page

The Network page displayed in Figure 7-4 allows the user to configure settings that are related to the CC5MPX network connectivity.

To clarify, this manual will refer to the selection tabs that are located on the left of some of the pages as Sub Tabs.

The main Network page has 5 Sub Tabs:

- Network
- Power Mode
- FTP Server
- SMTP Server
- Sntp

### 7.3.1 Network Settings

The most common network settings are displayed first in the Network Sub Tab. These settings are summarized in Table 7-1.

<b>Configuration Settings</b>	<b>Description</b>	<b>Default Value</b>
DHCP	Enables DHCP operation of the network interface. Operates as a Static IP address if Disabled.	Disabled
Network IP Address	Only set if DHCP is Disabled	192.168.1.90 (Static)
Network Mask	Only set if DHCP is Disabled	255.255.255.0
Default Gateway	Only set if DHCP is Disabled	192.168.1.1
Primary Name Server	Only set if DHCP is Disabled	192.168.1.1
HTTP Port	Alternate ports can be used for the http interface. Options are 80 or values between 1025 and 65535.	80

**Network**

---

DHCP  Enable  Disable

IP Address

Netmask

Default Gateway

Primary Nameserver

HTTP Port

**Figure 7-5 Network Settings**

### 7.3.2 Ethernet Power Mode Settings

Clicking on the Power Mode Sub Tab allows the user to edit the Ethernet Power Mode settings. To reduce power consumption, the CC5MPX includes the ability to control the power characteristics of the Ethernet port. 3 options are available (see Figure 7-6 Ethernet Power Savings Settings):

- **Always On**  
This power mode offers the maximum availability of the Ethernet port. If the camera is in the Fully On power state or the Partially On power state, then the Ethernet port will always be on and available for communications.
- **Moderate**  
This power mode offers some power savings on the Ethernet port. This mode is only recommended if the camera is in Partially On power mode. If the camera is in the Partially On power mode, then incoming data packets will wake up the camera for communications.

- Full Power Save  
This power mode should be used if the lowest power consumption is desired and incoming Ethernet communications are not required.



Figure 7-6 Ethernet Power Savings Settings

The specific behavior of the camera’s Ethernet power save is also influenced by the Power mode of the camera. Table 7-2 will help outline the Ethernet power saving features versus various Power modes of the camera.

Table 7-2 Ethernet Power Save Modes		
Camera Power Mode	Ethernet Power Save Mode	Operating Characteristics
Fully on	Always on	<ul style="list-style-type: none"> <li>* Camera is always on.</li> <li>* Highest power consumption.</li> <li>* Ethernet is on and always available for incoming communications.</li> </ul>
	Moderate Power Save Mode	<ul style="list-style-type: none"> <li>* Not recommended.</li> </ul>
	Full Power Save Mode	<ul style="list-style-type: none"> <li>* Camera is always on.</li> <li>* Average power consumption is reduced by 50mA @ 12 VDC.</li> <li>* Ethernet is normally turned off and is only enabled when outgoing communications are required (email or FTP).</li> <li>* User needs to push the Setup button to temporarily enable the Ethernet port for webpage access.</li> </ul>
Partially On	Always On	<ul style="list-style-type: none"> <li>* The camera is effectively off in a low powered state.</li> <li>* Typical power consumption is 80mA @ 12 VDC.</li> <li>* Ethernet is always on and always available for incoming communications.</li> <li>* The camera will temporarily wake up to the fully on power mode when traffic occurs on the network. In situations where there is constant network traffic then the camera may effectively be in the fully on power mode.</li> </ul>
	Moderate Power Save Mode	<ul style="list-style-type: none"> <li>* The camera is effectively off in a low powered state.</li> <li>* Typical power consumption is 80mA @ 12 VDC.</li> <li>* Ethernet is always off.</li> </ul>

		<ul style="list-style-type: none"> <li>* Disconnecting and connecting the camera to another Ethernet device will momentarily wake up the camera to allow it to process incoming communications. The camera will go into the low powered mode again if no communications occur.</li> </ul>
	Full Power Save Mode	<ul style="list-style-type: none"> <li>* The camera is effectively off in a low powered state.</li> <li>* Average power consumption is typically 10mA @ 12 VDC.</li> <li>* The Ethernet is normally turned off and is only enabled when outgoing communications are required (email or FTP).</li> <li>* User needs to push the Stup button to temporarily enable the camera and Ethernet port for webpage access.</li> <li>* The camera can respond to RS-232 and RS-485 communications in this mode.</li> </ul>
Deep Sleep	Always On	<ul style="list-style-type: none"> <li>* The Deep Sleep power consumption (6mA typically) is not affected by the Ethernet Power Mode.</li> <li>* Ethernet, RS-232 and RS-485 communications are non-responsive in Deep Sleep state.</li> </ul>
	Moderate Power Save Mode	<ul style="list-style-type: none"> <li>* Not recommended.</li> </ul>
	Full Power Save Mode	<ul style="list-style-type: none"> <li>* The Deep Sleep power consumption (6mA typically) is not affected by the Ethernet Power Mode.</li> <li>* If Ethernet communications are not used this can reduce the power consumption of the camera by 50mA when the camera exits the Deep Sleep state.</li> </ul>
Off State	Always On	<ul style="list-style-type: none"> <li>* The Off state power consumption (1mA typically) is not affected by the Ethernet Power Mode.</li> <li>* Ethernet, RS-232 and RS-485 communications are non-responsive in Off state.</li> </ul>
	Moderate Power Save Mode	<ul style="list-style-type: none"> <li>* Not recommended.</li> </ul>
	Full Power Save Mode	<ul style="list-style-type: none"> <li>* The Off state power consumption (1mA typically) is not affected by the Ethernet Power Mode.</li> <li>* If Ethernet communications are not used this can reduce the power consumption of the camera by 50mA when the camera exits the Off State.</li> </ul>

### 7.3.3 FTP Client Set-up

Clicking on the FTP Server Sub Tab will display the FTP Server settings (see Figure 7-7)

The screenshot shows a web interface for configuring FTP server settings. The title is "FTP Server Setting". There are two server configuration sections, "Server #1" and "Server #2".

**Server #1:**

- FTP Server Address: 192.168.1.170
- User Name: cc5mpx
- Password: \*\*\*\*\*
- File Upload Path: /74
- Passive Transfer Mode:
- Port: 21

**Server #2:**

- FTP Server Address: [Empty]
- User Name: [Empty]
- Password: [Empty]
- File Upload Path: [Empty]
- Passive Transfer Mode:
- Port: 21

A "Submit" button is located at the bottom center of the form.

**Figure 7-7 FTP Server Settings**

These settings configure the CC5MPX to be able to act as a FTP client to send image files to an FTP server. There are settings for two different servers.

These settings simply configure the parameters that the camera will use to connect to the server. The FTP transfers must be enabled in the Image Capture menus. When specifying an FTP connection, the user can select between active and passive mode file transfers. The default setting is the passive mode. This mode allows a camera connected through a firewall to transfer files properly through the firewall to the remote server.

In the event of an FTP transfer failure, the CC5MPX will retry sending the file to the FTP server up to 2 times before aborting the file transfer.

The CC5MPX can also act as an FTP server to enable images and video to be transferred from the memory card. See Section 5.4.3 FTP Image Collection from the Memory Card for more details.

**Note**

If connecting the CC5MPX to the IPn3Gb Cellular Modem, please refer to *CC5MPX Digital Camera and IPn3Gb Cellular Modem Application Note (3T-Z)* available at <https://www.campbellsci.ca/cc5mpx> under *Documents*.

### 7.3.4 SMTP (Email) Server Settings

Clicking on the SMTP Server Sub Tab will display the SMTP (email) server settings (see Figure 4). The CC5MPX can send images or video via email by using two different email servers.

Many SMTP servers are capable of using TLS encryption to securely communicate with email clients. Some SMTP servers, such as Google Gmail, require secure connections in order to allow access. Support for TLS encryption is available in the CC5MPX SMTP program. If the CC5MPX connects to an SMTP server that

supports TLS encryption, it will automatically be used, otherwise it will return to a normal, unencrypted connection.

In the event of a SMPT transfer failure, the CC5MPX will retry sending the file to the mail server up to 2 times before aborting the file transfer.

Details on the settings are as follows:

- **My server requires authentication**  
Check off this setting if the email server requires authentication. This usually means that a login is required, with a username and password.
- **Account Name**  
The Account Name is required only if Authentication is used.
- **Password**  
The Password is required only if Authentication is used.
- **Sender**  
The EMAIL address associated with the account is normally used here. The CC5MPX cannot receive emails.
- **SMTP Server**  
Enter the address of the SMTP server that is being used. Enter the SMTP server port number as part of the SMTP address, if required. The camera will default to port 25 if a value is not included. An example of a port number entry is: mail.server.com:587
- **Email address**  
Enter the destination email addresses that are to receive the emails. Multiple email addresses can be included. There is a limit of 255 characters.  
For multiple email addresses, use a space, comma or semi-colon as a separator between addresses. Ex:  
[test1@somewhere.com;john@email.com](mailto:test1@somewhere.com;john@email.com)

**SMTP Server Setting**

**Server #1**

My Server Requires Authentication

Account Name

Password

Sender

SMTP Server

Email Address

**Server #2**

My Server Requires Authentication

Account Name

Password

Sender

SMTP Server

Email Address

**Figure 7-8 SMTP Server Settings**

### 7.3.5 SNTP (TIME) Server Setting

Clicking on the SMTP Server Sub Tab will display the SNTP (TIME) server settings (see Figure 7-9). The configuration of an SNTP server provides a means of synchronizing the onboard clock of the CC5MPX with the specified SNTP server. This ensures that the camera clock is always accurate. It is also possible to configure a time zone offset for the camera.

Other than the address of the SNTP server, the time zone needs to be selected and the Automatic adjustment of Daylight savings time can also be selected.

Following are two examples of SNTP servers:

Canadian address for the SNTP time servers:

**ca.pool.ntp.org**

United States address for the SNTP time servers:

**us.pool.ntp.org**

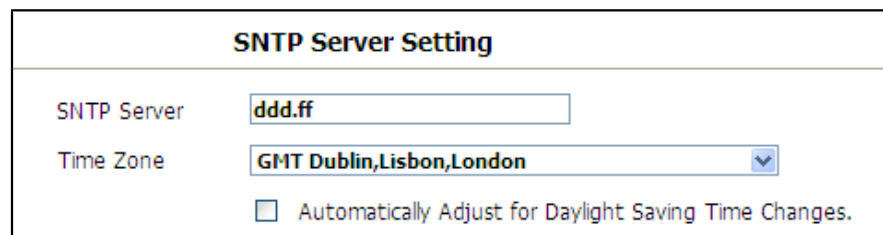

SNTP Server Setting	
SNTP Server	<input type="text" value="ddd.ff"/>
Time Zone	<input type="text" value="GMT Dublin,Lisbon,London"/>
<input type="checkbox"/> Automatically Adjust for Daylight Saving Time Changes.	

Figure 7-9 SNTP Server Settings

## 7.4 System Configuration

Selecting the System tab activates the System Settings page (see Figure 7-10 System Settings). The main System Settings page has 8 Sub Tabs:

- Date and Time
- Automatic Date and Time Update
- Site Name
- Users/Security
- Digital I/O
- Update
- Events
- Save/Read Camera Settings



The screenshot shows the 'Date and Time' configuration page for a Campbell Scientific CC5MPX camera. The interface includes a top navigation bar with tabs for Live Video, Network, System, Memory Card, Video Settings, Image Capture, Communication Settings, and Still Image Settings. The main content area is titled 'Date and Time' and contains the following sections:

- The Local Time:** Displays 'Daylight Saving Time is Active' and shows the current date (2012/08/02), time (18:20:54), and weekday (Thursday).
- The Desired Time:** Offers three options:
  - Set Manually:** Includes dropdown menus for Date (YYYY/MM/DD) and Time (HH:MM:SS).
  - Synchronize with Computer Time:** Shows the computer's current date and time.
  - Synchronize with SNTP Server:** Includes a text field for the SNTP Server (ca.pool.ntp.org) and a dropdown for the Time Zone (GMT-07 Mountain Time (US & Canada), Arizona).
- Date Format:** A dropdown menu set to YYYY/MM/DD.
- Submit:** A button at the bottom to apply the changes.

Figure 7-10 System Settings

### 7.4.1 System Date and Time

The Date and Time submenu (see Figure 7-11) provides a means for viewing and setting the current Date and Time of the camera. Available options include:

- **Setting the Time manually:**  
Select the Set Manually button, and then select the date and time values from the drop down boxes. You must click on the Submit button for the settings to take effect.
- **Synchronize with computer time:**  
The webpage also displays the time reported by your computer. If this is the desired time, select the button and click on Submit. The camera time will be updated with the computer time.
- **Synchronize with SNTP server**  
If an appropriate SNTP Time server is set up in the Network Settings, this button can be selected to use an Internet SNTP time server. Clicking on Submit starts the process.

Figure 7-11 Date and Time Settings

### 7.4.2 Automatic Date and Time Update

The Automatic Date and Time submenu (see Figure 7-12) configures the camera for automatic date and time updates. The setting parameters are:

- Time Variance in seconds to perform clock update. Select the minimum allowable variance that will result in the camera’s time being changed.
- Source  
 Select 1 of 3 options for the Automatic Time updates. The possibilities are:
  - \*None  
 The camera’s clock is highly accurate and its drift is normally less than 2 min/year.
  - \* PakBus Port  
 Normally this is a datalogger. The actual time update occurs only when a file transfer occurs to the datalogger from the camera.
  - \*SNTP Server  
 The camera will use the SNTP Time server that is specified under Network settings (see Section 7.2.5). A proper network connection is also required. The time will update on every power up and wake out of of sleep mode, as well as every 8 hours in Fully On mode.

Figure 7-12 Automatic Date and Time Update

### 7.4.3 Site Name

The Site Name submenu (see Figure 7-13) allows a site name to be used for a webpage heading. By default, the Site Name is set to Campbell Scientific. This provides an easy way of confirming that the camera is connected to the web interface. The Site Name is limited to 32 characters.

Refer to Figure 5 for the location of the Site Name on the webpages.

Figure 7-13 Site Name

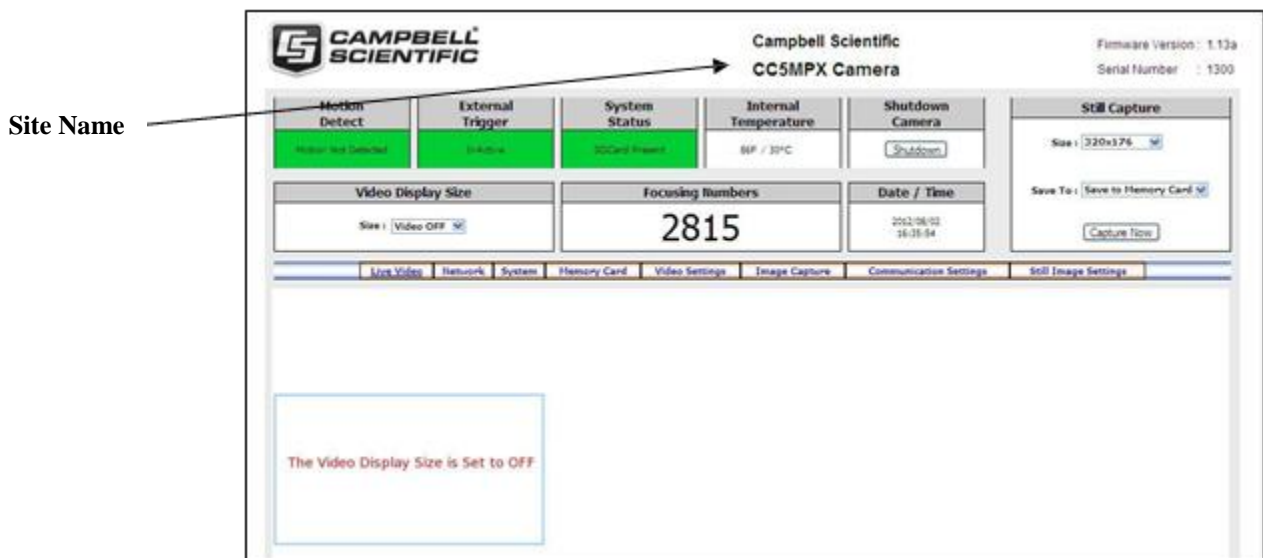

Figure 7-14 Location of Site Name

### 7.4.4 Users and Security

The Users/Security submenu (see Figure 7-15) allow for setting of security features in the CC5MPX.

By default, cameras are shipped with the security authentication disabled. When the Authentication setting is set to Enable, users will be prompted for a User Name and Password before access is given. By default, one user is set up with the user name of Admin and the password of 9999. Ensure that a record of User names and passwords are kept. In the event that this information is lost, and you can no longer access your camera, the settings can be viewed or changed by connecting the camera to a computer with the Device Configuration Utility, using the RS-232 port.

In order to add a User, you will need to fill out the 'Add/Modify Users' parameters, select the required Authority level, and Submit the new User. Once the camera

saves the action, the User list will show the User name and their authority level. The User name and password must be 4-32 characters in length.

Authority Level Access:

- Admin
  - o Full camera access
  - o Can create and edit users and disable security
- Operator
  - o Full camera access
  - o Only restriction is Security Settings
- Viewer:
  - o Only access to the Live Video Homepage and the Memory Card Page is given
  - o No settings can be changed
  - o Only read access to the Memory Card is allowed

Figure 7-15 Users and Security Settings

If a user needs to be removed from the User List, this must be done by a user with Admin access. Remember that any deletion or changes will only be saved when the submit button is clicked.

### 7.4.5 Digital I/O Settings

**Note**

The light and communication power are multiplexed on the same wire on the connector. If both powers are enabled, the output remains on from when the start of capture to when the file is transfer is complete.

The Digital I/O submenu (see Figure 7-16) allows the configuration of some of the camera's I/O signals.

Digital I/O Setting	
External Trigger Input	
Select Active High or Low	High ▾
Light Power Control	Not Used ▾
Communication Power Control	<input checked="" type="radio"/> Enable <input type="radio"/> Disable
Communication Warm up Time	0 Seconds ( From 0 ~ 300 )
Heater Power control	<input checked="" type="radio"/> Enable <input type="radio"/> Disable
Heat when temperature is below	0 °C ( From -40 ~ 25 )
On Duration	<input checked="" type="radio"/> Always On <input type="radio"/> Minutes prior to schedule 0 ( From 0 ~ 59 )

Figure 7-16 Digital I/O Settings

#### 7.4.5.1 External Trigger Input Settings

The External Trigger Input can be configured to Active High or Active Low. When set to Active High 0 volts will be the Inactive state and a positive voltage will be the Active state.

The CC5MPX is shipped from the factory by default with a pull down resistor connected to the External Trigger Input and the External Trigger is set to Active High. With this default setting, when no signal is applied to the input the External Trigger is inactive. A positive voltage is required to change to the active state.

#### 7.4.5.2 Light Power Control Settings

The camera can be configured to switch the external +12 V on, based on the available light in the scene (Yellow wire). There are 3 settings: Not Used, Active, and Flash Type. 'Not Used' disables the output, while the other 2 enable it.

There are future plans to add 2 different modes of operation, but currently they operate in the same manner. The light will only come on when capturing from a self-timed capture or when an external trigger occurs while the camera is in sleep mode. The light does not turn on for motion detection capture. The light turns off after the capture is complete.

#### 7.4.5.3 Communication Power Control

The Communication Power Control setting controls the Communication Switched Power Output line on the Power I/O cable of the CC5MPX camera.

The switch output is intended to manage the power to a communication device, such as a cell modem. This is useful in a solar powered site when there is a need to limit power consumption of communication devices.

This option enables the CC5MPX to supply up to a maximum of 750 mA of current. The voltage level will be the same as the camera's input power (i.e. 12 VDC).

Some modems will require a warm up time or a period of time to register on a network. The Communication warm up time parameter allows an appropriate time to be entered for this purpose.

#### 7.4.5.4 Heater Power Control

The Heater Power Control setting controls the operation of the optional window defroster. If enabled, the camera will only turn on the heater if the current internal temperature is below the threshold setting. The temperature threshold values are limited to -40°C to +25°C.

If the Always On option is selected, the heater will be on whenever the temperature is below the threshold and the camera is not in a low powered state.

If Minutes prior to schedule is selected, the camera will wake up prior to any of the Self-Times schedules and turn on the heater if the temperature is below the threshold settings. This feature does not work with motion detection or external trigger modes.

This is useful for a remote site that may be prone to riming and frost. A camera that is setup to take hourly pictures can be configured to turn on the defroster several minutes prior to the scheduled picture to defrost the window.

#### 7.4.6 Update

The Update I/O submenu (see Figure 7-17) provides the ability to update the firmware in the camera. It is recommended to check for firmware updates on the Campbell Scientific website to ensure that the camera has the most recent version of firmware.

Once a file is downloaded, click on the Browse button to select the new firmware update with the 'tar.gz' file extension. Once the proper file is selected, click on the Update button and the process will begin.

#### Note

**During the update process DO NOT disconnect power, close web browser, or navigate away from the Update page. Once the update is downloaded, unzip the .tar.gz file and save to the desired location. DO NOT uncompress the .tar.gz file, send as is to camera.**

Once the firmware update process is completed a webpage will be displayed indicating that the process has completed. The camera will reboot itself. It will take a few minutes for the camera to operate as normally.

The firmware update process normally keeps all configuration settings in the camera. It is recommended to verify the settings after an update.



The screenshot shows a web interface titled "Update Firmware". At the top, it displays "Firmware Version: 0.16". Below this, it says "Update the device with the latest firmware." and "Select the firmware file:". There is a text input field followed by a "Browse..." button and the text "and click" followed by an "Update" button. A red "Note" is displayed: "Do not disconnect the power of the device or do not close the web browser window or do not navigate to other page during the update." At the bottom, there is a "Restart" button and a red "Warning: CC5HPX will restart immediately!!".

Figure 7-17 Update Menu

## 7.4.7 Events

The Events submenu (see Figure 7-18) provides a list of system events. If the System Status box is red in the Live Video page, the details are logged in the Events Log. One of the most common recorded events is the indication that memory card is properly present after a power up. The message confirms that the memory card is functioning and it also indicates the size of the memory card.

Other types of event messages and log files include:

- The memory card or the allocated memory is full (when fill and stop memory management is used)
- Communication and file transfer errors that include:
  - o FTP
  - o Email
  - o PakBus

Item	Date and Time	Events
1.	2011-01-28 10:56:08	SDCard Fill and Stop - Self-timed 1 Still
2.	2011-01-28 10:50:51	SDCard Present (3979 Mbytes)
3.	2011-01-28 09:10:07	SDCard Fill and Stop - Self-timed 1 Still
4.	2011-01-28 09:00:21	SDCard Present (3979 Mbytes)
5.	2011-01-28 08:40:00	SDCard Fill and Stop - Self-timed 1 Still
6.	2011-01-28 08:39:59	EMAIL File TX Fail - Trigger Still
7.	2011-01-28 08:35:54	SDCard Present (3979 Mbytes)
8.	2011-01-28 08:32:52	EMAIL File TX Fail - Trigger Still
9.	2011-01-28 08:10:00	SDCard Fill and Stop - Self-timed 1 Still
10.	2011-01-28 08:04:28	SDCard Present (3979 Mbytes)
11.	2011-01-27 16:36:19	EMAIL File TX Fail - Trigger Still
12.	2011-01-27 16:20:00	SDCard Fill and Stop - Self-timed 1 Still
13.	2011-01-27 16:09:12	SDCard Present (3979 Mbytes)
14.	2011-01-27 15:04:58	james login on 192.168.1.130
15.	2011-01-27 15:01:00	user1 login on 192.168.1.130
16.	2011-01-27 09:10:01	SDCard Fill and Stop - Self-timed 1 Still
17.	2011-01-27 09:04:34	SDCard Present (3979 Mbytes)
18.	2011-01-26 17:30:00	SDCard Fill and Stop - Self-timed 1 Still
19.	2011-01-26 17:21:34	SDCard Present (3979 Mbytes)
20.	2011-01-26 13:50:07	FTP File TX Fail - Self-timed 2 Still

Figure 7-18 Event Logs

## 7.4.8 Save/Read Camera Settings

This feature allows for configuration settings to be saved or loaded via the web interface. The .xml configuration files are also compatible with the Device Configuration Utility.

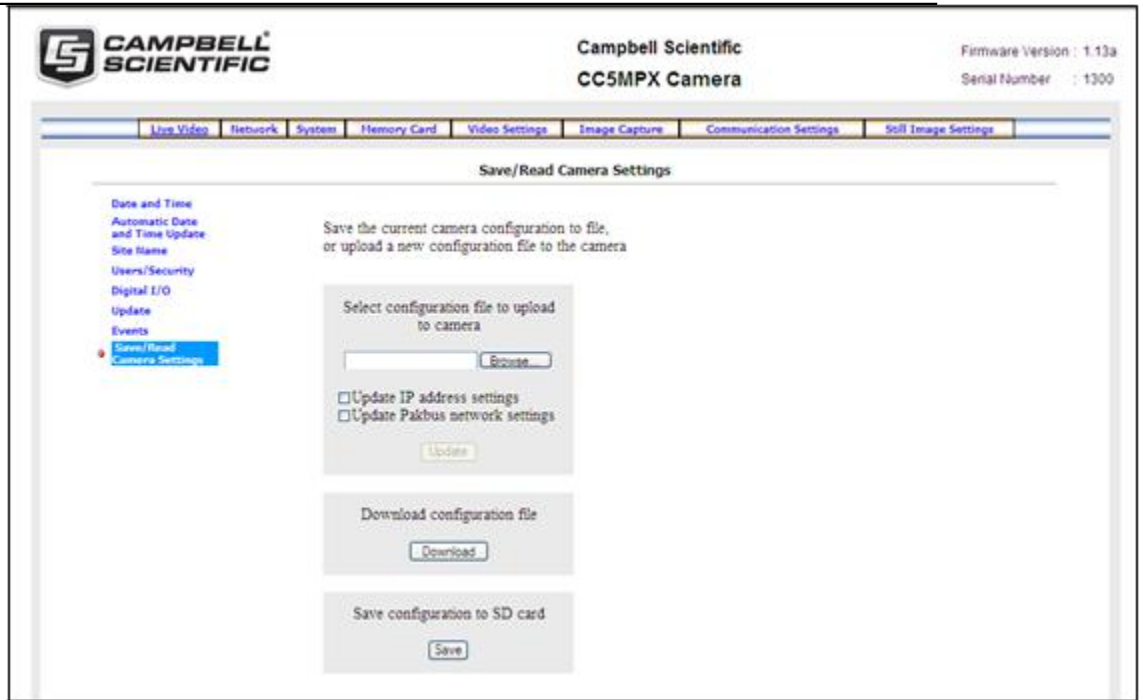

Figure 7-19 Save/Read Camera Settings

## 7.5 Memory Card

Selecting the Memory Card tab will bring up the Memory Card page (see Figure 7-20) and allow access to the internal SD card.

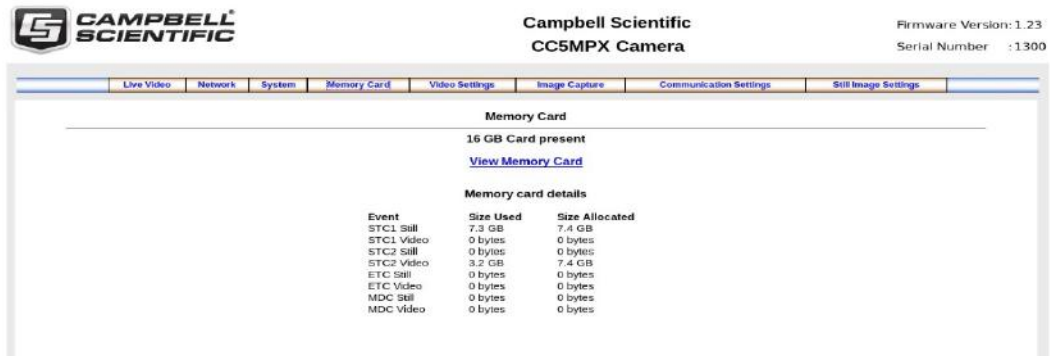

Figure 7-20 Memory Card Page

This page shows the size of the memory card loaded in the camera. If no camera is present, there will be a message stating so, and the view memory card link and memory card details will not appear.

Each capture event is allocated a limited amount of space on the SD card based on the settings on the event configuration page. As more space can be allocated on the event configuration page than is available on the SD card, the camera will automatically scale the allocated space to fit the SD card. This page shows the actual space available for each capture event, as well as the space currently being used.

Click on View Memory Card link to browse the files on the SD card.



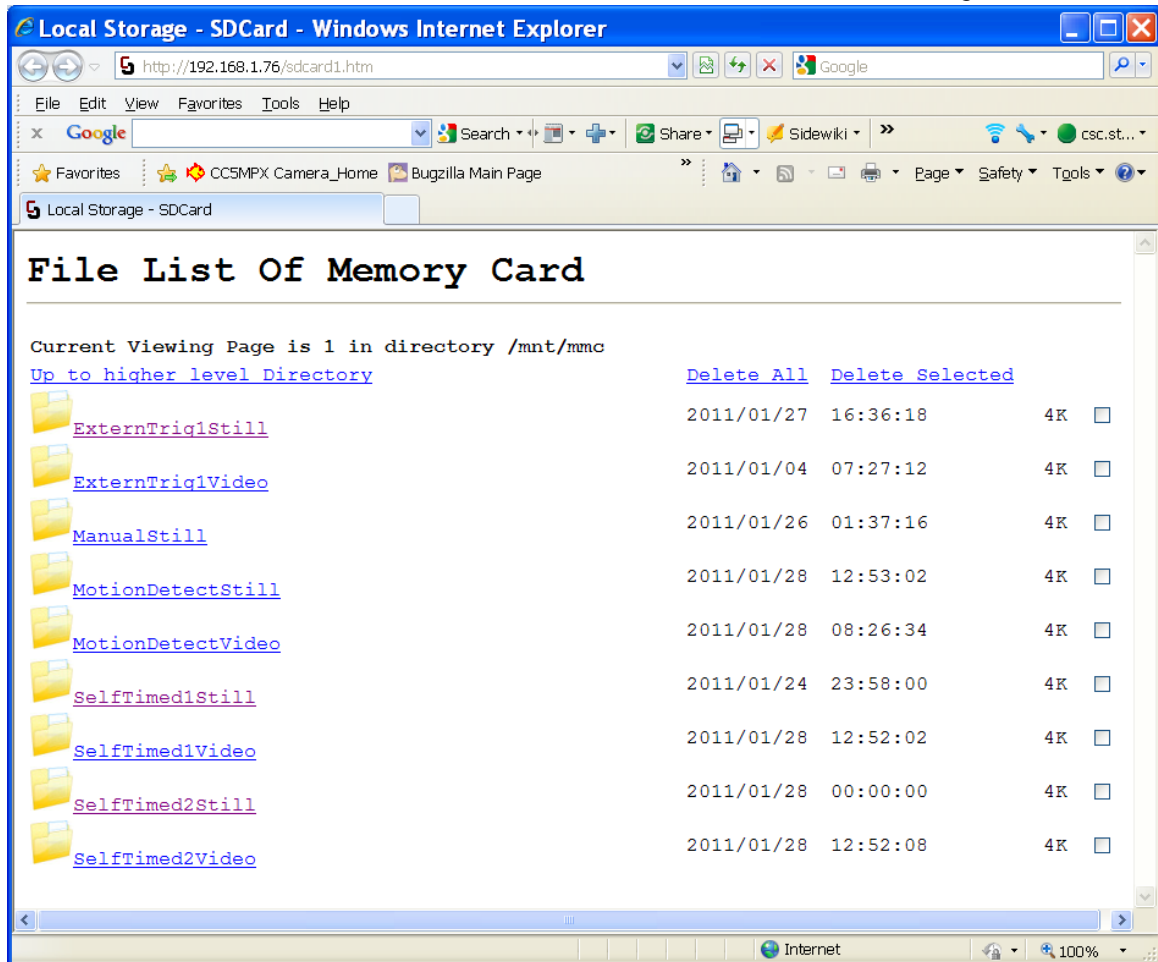

**Figure 7-21 Memory Card Directory Listing**

There is a possibility of nine Main directories that are created for Image and Video storage on the camera. There is a still image and video directory for each type of capture method and a directory for manually captured stills. A directory will not be created by the camera if the capture method is not used.

The directory names are:

- ExternTrigStill1
- ExternTrigStill1 Video
- ManualStill
- MotionDetectStill
- MotionDetectVideo
- SelfTimed1Still
- SelfTimed1 Video
- SelfTimed2Still
- SelfTimed2Video

Clicking on one of the main folders will display the contents inside. Normally another set of subfolders will be displayed. The camera creates subfolders that are named by date. The date subfolders can be configured to store images in folders named either by Year\_Month or Year\_Month\_Day (see Figure 7-22).

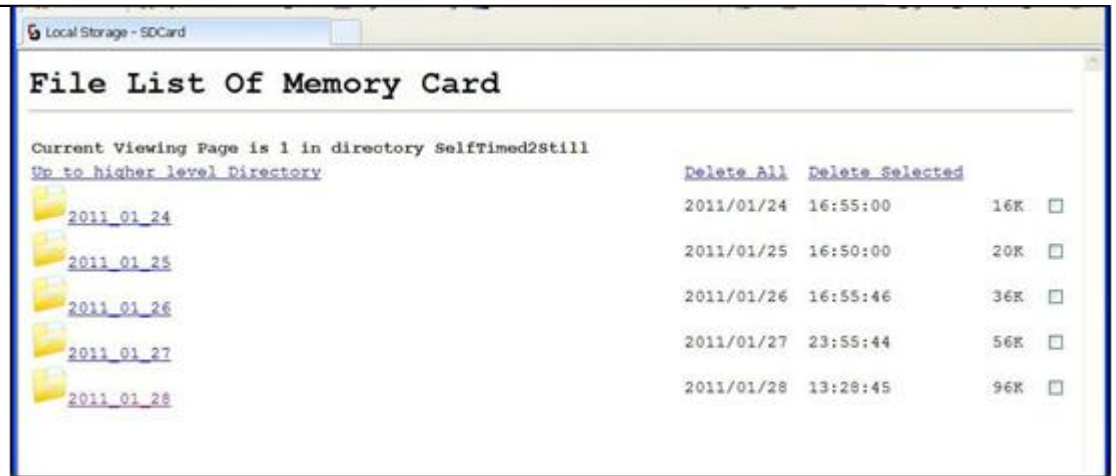

**Figure 7-22 Data Subfolders**

Actual pictures and video will be located in these subfolders and can be viewed as shown in Figure 7-23.

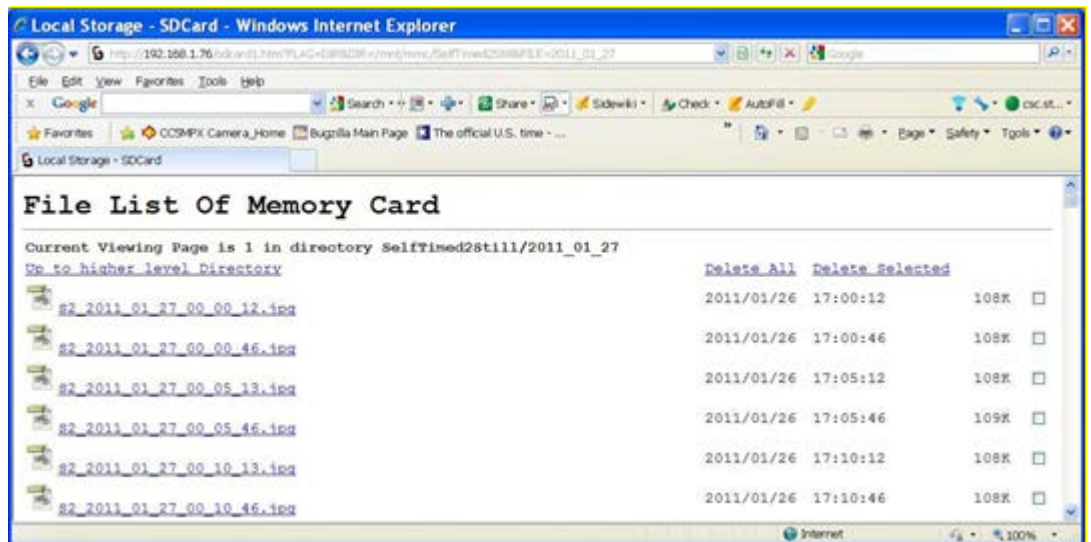

**Figure 7-23 Example Display of Files**

The web interface will display up to 200 files per page. If more files exist in the directory than at the very bottom of the page, other pages can be selected to view the additional files (see Figure 7-24).

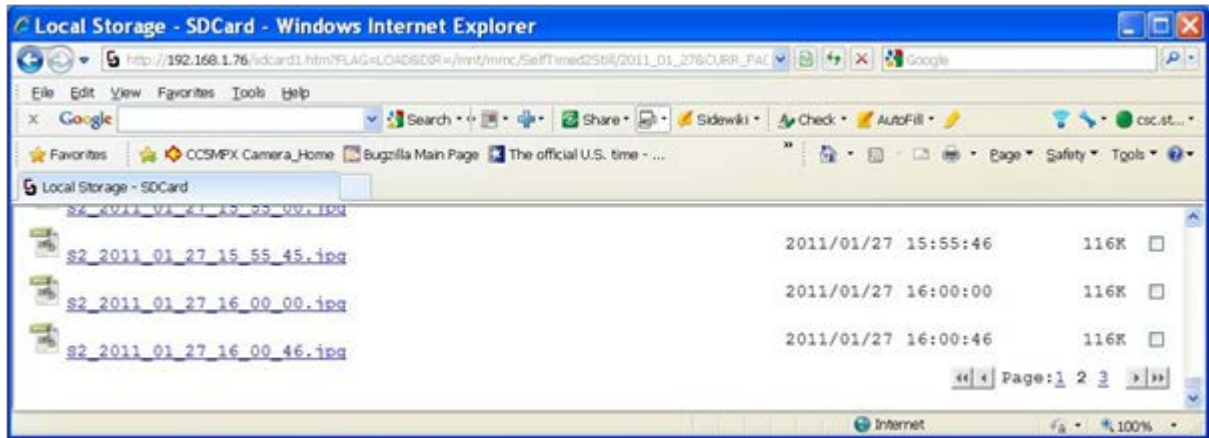

Figure 7-24 Example of Multiple Page Viewing

The web interface provides a method of viewing or deleting images and video from the memory card. It is possible to delete either complete or portions of Directories or Subfolders as well as individual images or videos. Be cautious when using the Delete All function.

## 7.6 Video Settings

Selecting the Video Settings tab will bring up the Video Settings page (see Figure 7-25). There are 2 sub tabs that provide 2 independent types of video to be recorded.

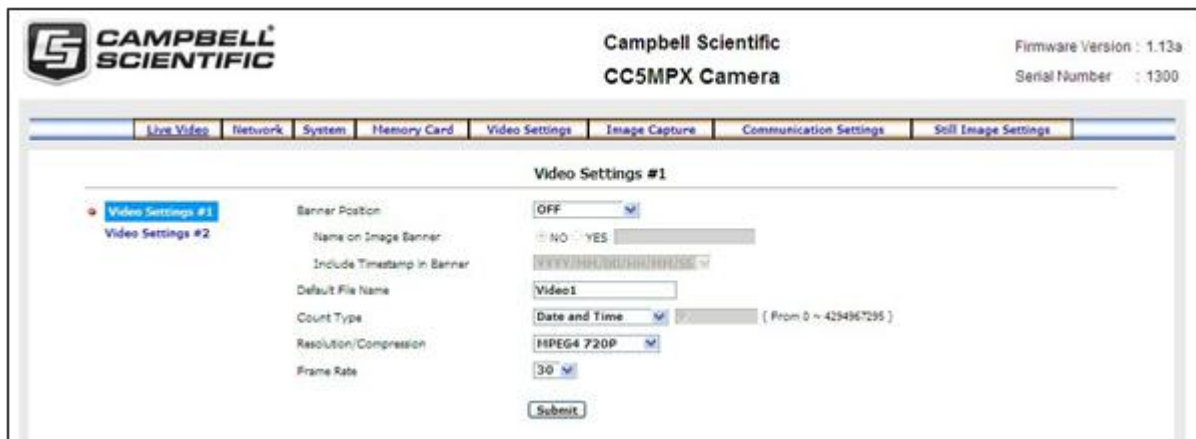

Figure 7-25 Video Settings Page

The video Settings consist of the following parameters:

- Position Banner

3 available options are:

- OFF
- Inside Top
- Inside Bottom



**Figure 7-26 Video Banner Inside Top with Timestamp and Text**

- **Name on Image Banner**  
If YES is selected, text can be entered which would appear in the video banner. Refer to Section 11 for details on how to alter the Banner via a PakBus datalogger.
- **Include Timestamp in Banner**  
There are 5 options for the style of timestamp to include in the banner text:
  - \* None
  - \* YYYY/MM/DD HH:MM:SS
  - \* MM/DD/YYYY HH:MM:SS
  - \* MM/DD/YYYY HH:MM
  - \* MM/DD/YYYY
- **Default File Name**  
A more meaningful file name can be assigned to the files. The maximum number of characters is 31. No spaces are allowed within the file name.
- **Count Type**  
There are 3 options available for Count Type:

**None**

When using None, the same file will simply be overwritten on the memory card every time a video is recorded. This may also happen for the transmitted files that are sent via FTP.

**Number Increment**

A unique number is appended to each file name. When the Number Increment is selected an additional box will allow a starting number to be entered. An example of a file name with the count type is:

Video1\_0000001994.avi

**Date and Time**

Each file name will have a timestamp appended to it. Examples of file names with Date and Time option are:

Video1\_2011\_01\_28\_14\_22\_10.avi

Video1\_YYYY\_MM\_DD\_HH\_MM\_SS.avi

- **Resolution/Compression**  
Currently there are 2 options for the video capture format. Both options encode the video using MPEG4. The options are 1280 x 720 (720P) or 320 x 240.
- **Frame Rate**  
There are 3 frame rate options of 30, 15, and 7.5 frames per second (FPS). Lower frame rates can reduce the file sizes.

The video resolution and frame rate are the 2 factors that determine the file size for video files. Table 7-3 shows the approximate file size for every second of recorded video. According to the table, the largest file sizes are produced by the 720P 30FPS video, which is 500Kbytes per second of video. The smallest video files are produced by the 320 x 240 7.5 FPS video which is 9 Kbytes per second of video.

<b>Resolution</b>	<b>Frames Per Second</b>	<b>Kbytes per Second</b>
720P 1280 x 720	7.5	125
	15	250
	30	500
320 x 240	7.5	10
	15	20
	30	65

## 7.6.1 GPS Coordinates

GPS coordinates (*CC5MPXGPSLatitude* and *CC5MPXGPSLongitude*) can be embedded in the image or video files that the camera generates. 2 PakBus variables allow the logger to send the GPS coordinates to the camera, where they are embedded in the images or video.

The GPS coordinates must be sent as floating point values. Positive latitude and longitude represent northern and eastern hemispheres, respectively. While negative values represent southern and western hemispheres, respectively. Values are not saved through a power cycle, or in off-mode, but do not need to be updated every time an image or video is sent.

### 7.6.1.1 Example Program – Adding GPS Coordinates to the Image Banner

The following example illustrates the use of the *CC5MPXGPSLatitude* and *CC5MPXGPSLongitude* instructions, which can be used with CR800 series, CR1000, or CR3000 dataloggers.

```

Public sendGps As Boolean
Public gpsLat, gpsLong As Float
public sendVarResult

BeginProg
  sendGps = false
  gpsLat = 50.0
  gpsLong = -139.0
  SerialOpen (Com1,115200,4,0,2000)

Scan (1,Sec,0,0)
  If sendGps Then
    sendGps = false
    SendVariables
    (sendVarResult,Com1,0,55,0000,0,"Public","CC5MPXGPSLatitude",gpsLat, 1)
    SendVariables (sendVarResult,Com1,0,55,0000,0,"Public","CC5MPXGPSLongitude",gpsLong,
1)
  EndIf

NextScan
EndProg

```

## 7.7 Image Capture

Selecting the Image Capture tab will bring up the Image Capture settings page (see Figure 7-27). The Image Capture settings are the most significant settings in determining how the camera will operate.

There are 6 sub tabs that include:

- Power Modes
- Self-Timed Capture
- External Trigger
- Motion Detection
- Read/Save Camera Settings

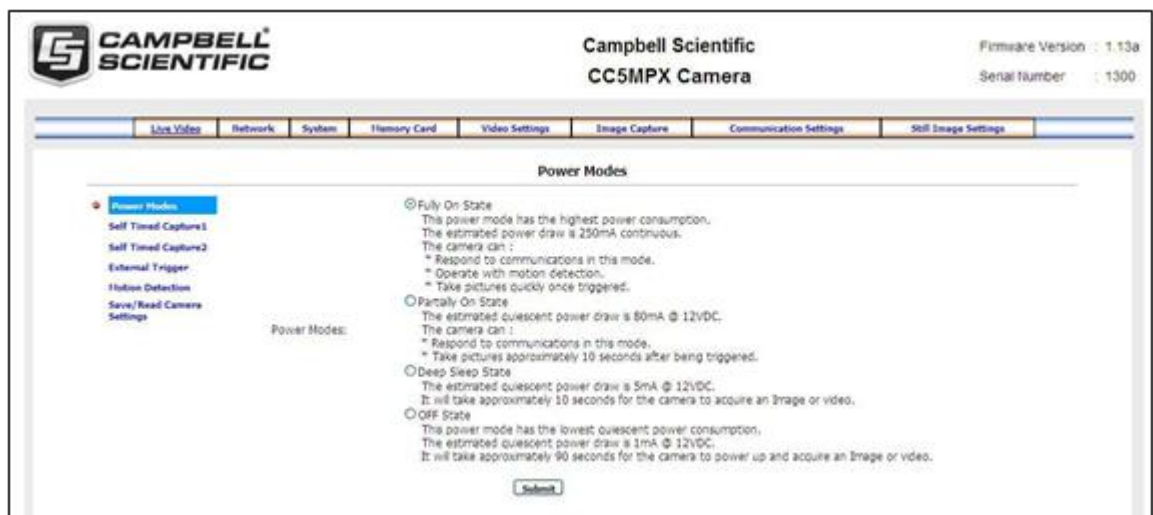
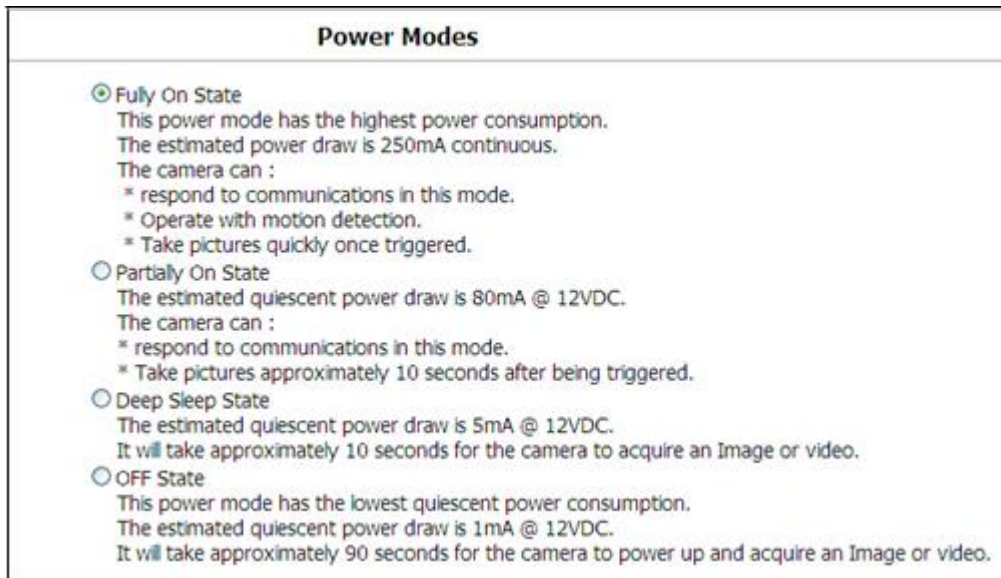

Figure 7-27 Image Capture Page

### 7.7.1 Power Modes

The Power Modes Sub Tab (see Figure 7-28) allows for selection of the type of power management that will be used.



**Figure 7-28 Power Modes**

One of the main factors in determining which power mode to use is the power consumption budget that is available for the camera.

If the camera is operating from an AC main power supply, then the camera will have the best performance characteristics in the Fully On State. On the other hand, if the camera needs to operate from a battery for long periods of time, then the OFF state is more suitable.

Table 7-4 - Capture Response Time shows typical response times from when a trigger occurs to the time that a picture or video is taken. The OFF state takes the longest as the Main processor is not powered on in this state and it must completely boot up to operate again from the OFF state.

<b>Table 7-4 Power Modes</b>		
<b>Power Mode</b>	<b>Ethernet Power Save Mode</b>	<b>Operating Characteristics</b>
Fully On	Always On	<ul style="list-style-type: none"> <li>* Camera is always on</li> <li>* Highest power consumption</li> <li>* Ethernet is on and always available for incoming communications</li> </ul>
	Moderate Power Save Mode	<ul style="list-style-type: none"> <li>* Not recommended</li> </ul>
	Table text	<ul style="list-style-type: none"> <li>* Camera is always on</li> <li>* Average power consumption is reduced by 50mA @ 12 VDC</li> <li>* The Ethernet is normally turned off and is only enabled when outgoing communications are required (email or FTP)</li> <li>* User needs to push the Setup button to temporarily enable the Ethernet port for webpage access</li> </ul>
Partially On	Always On	<ul style="list-style-type: none"> <li>* The camera is effectively off in a low powered state</li> <li>* Typical power consumption is 80 mA @ 12 VDC</li> <li>* Ethernet is on and always available for incoming communications</li> <li>* The camera will temporarily wake up to the fully on power mode when traffic occurs on the network. In situations where there is constant network traffic, the camera may effectively be in the Fully On power mode</li> </ul>
	Moderate Power Save Mode	<ul style="list-style-type: none"> <li>* The camera is effectively off in a low powered state</li> <li>* Typical power consumption is 80 mA @ 12 VDC</li> <li>* Ethernet is always off</li> <li>* Disconnecting and connecting the camera to another Ethernet device will momentarily wake up the camera to allow it to process incoming communications. The camera will go into the low powered mode again – if no communications occur.</li> </ul>
	Full Power Save Mode	<ul style="list-style-type: none"> <li>* The camera is effectively off in a low powered state</li> <li>* Average power consumption is typically 10 mA @ 12 VDC</li> <li>* The Ethernet is normally turned off and is only enabled when outgoing communications are required (email or FTP)</li> <li>* User needs to push the Setup button to temporarily enable the Ethernet port for webpage access</li> <li>* The camera can respond to RS-232 and RS-485 communication in this mode.</li> </ul>
Deep Sleep	Always On	<ul style="list-style-type: none"> <li>* The Deep Sleep power consumption (6mA typically) is not affected by the Ethernet Power Mode</li> <li>* Ethernet, RS-232 and RS-485 communications are non-responsive in Deep Sleep mode</li> </ul>
	Moderate Power Save Mode	<ul style="list-style-type: none"> <li>* Not recommended</li> </ul>
	Full Power Save Mode	<ul style="list-style-type: none"> <li>* The Deep Sleep power consumption (6mA typically) is not affected by the Ethernet Power Mode</li> </ul>



		* If Ethernet communications are not used this can reduce the power consumption of the camera by 50mA when the camera exits the Deep Sleep state
Off State	Always On	* The Off State power consumption (1mA typically) is not affected by the Ethernet Power Mode * Ethernet, RS-232 and RS-485 communications are non-responsive in the Off State
	Moderate Power Save Mode	* Not recommended
	Full Power Save Mode	* The Off State power consumption (1mA typically) is not affected by the Ethernet Power Mode * If Ethernet communications are not used, this can reduce the power consumption of the camera by 50 mA when the camera exits the deep sleep state

---

**Note** See Section 7.2.2 Ethernet Power Mode Settings for other settings that influence power consumption.

---

<b>Power Mode</b>	<b>Typical Capture Time from Trigger Event</b>
Fully On	< 1 second
Partially On	10 seconds
Deep Sleep	15 seconds
Off State	90 seconds

## 7.7.2 Self-Timed Capture1

The Self-Timed Capture1 Sub Tab (see Figure 7-29) is used to configure the camera to capture still images or video using the internal clock of the CC5MPX.

The screenshot displays the 'Self-Timed Capture1' configuration page for a Campbell Scientific CC5MPX camera. The interface includes a top navigation bar with tabs for Live Video, Network, System, Memory Card, Video Settings, Image Capture, Communication Settings, and Still Image Settings. The 'Image Capture' tab is selected. The main configuration area is divided into two sections: 'Self-Timed Capture' and 'Video Capture'. The 'Self-Timed Capture' section includes settings for Start Minutes (0), Stop Minutes (0), Capture Interval (10), and Still Image Capture (YES). It also features options for Number of Images (1), Image Interval (1), and Capture To Memory Card (CARD). The 'Video Capture' section includes settings for Duration In Seconds (30) and Capture To Memory Card (CARD). A 'Submit' button is located at the bottom of the page.

Figure 7-29 Self-Timed Capture Page

When either of the Self-Timed Capture triggers is enabled, the CC5MPX uses its internal clock as a trigger to initiate the capture of still images or video. In addition to the Self-Timed Capture1 there is also a second independent Self-Timed Capture2. Each configuration is independent of the other, but overlapping events may delay or prevent one or the other from occurring. For example, 2 video recordings or still image captures cannot occur at the same time.

The first step in setting up the Self-Timed Capture is to select the Enable option for the capture method (see Figure 7-30). Once Enable is selected, parameters for the capture method can be edited.

Self Timed Capture1	
Self Timed Capture	<input checked="" type="radio"/> Enable <input type="radio"/> Disable
Start Minutes	<input type="text" value="0"/> Minutes from Midnight ( From 0 ~ 1439 )
Stop Minutes	<input type="text" value="0"/> Minutes from Midnight ( From 0 ~ 1439 )
Capture Interval	<input type="text" value="5"/> Minutes ( From 0 ~ 1439 )

**Figure 7-30 Enable and Capture Time Values**

The Self-Timed Capture triggers are set up with the timing relative to midnight. The first parameter to enter is the Start Minutes relative to midnight. The Start Minutes parameter is the first occurrence of a capture event after midnight. If the first timed event is to begin right at midnight, then set this parameter to zero. If the first timed event is at 7:00am, then Start Minutes would be set to 420 as there are 60 minutes per hour, and the start time is 7 hours after midnight (7 hours \* 60 minutes/hour = 420 minutes).

Similarly, the Stop Minutes specifies when the capture event is to stop relative to midnight. Set the Stop Minutes to 0 if there is no stop time. If a stop time such as 7:00 pm (1900h) is desired, then enter the value of 1140 as there are 60 minutes per hour, and the stop time is 19 hours past midnight (19 hours \* 60 minutes/hour = 1140 minutes).

Illustrations of the Start and Stop Times are shown in Table 7-6.

Table 7-6 Start and Stop Time Examples	
Start and Stop Time Settings	Graphical Illustration on a 24 hour Clock
Start Minutes = 0 Stop Minutes = 0	
Start Minutes = 420 (07:00H) Stop Minutes = 1140 (19:00H)	
Start Minutes = 1260 (21:00H) Stop Minutes = 480 (08:00H)	

The Capture Interval is the time between capture events once the Start Minutes value is reached. For hourly pictures, a value of 60 can be entered. If a value of 0 is entered (not recommended), the Image Interval time will apply to still images and video of the specified duration will be captured repeatedly.

Table 7-7 summarizes all the parameters associated with the Self-Timed Capture.

**Table 7-7 Self-Time Capture Variables**

<b>Variable</b>	<b>Allowable Values</b>	<b>Description</b>
Self-Timed Capture Enable	* Enable * Disable	Enables or Disables the Self-Timed Capture Trigger
Start Minutes	0 to 1439	Start time in minutes relative to midnight
Stop Minutes	0 to 1439	Start time in minutes relative to midnight
Capture Interval	0 to 1439	Interval between capture times in minutes. To initiate a capture interval every 5 min set the variable to 5
Still Image Capture	* Yes * No	Select Yes to include still image captures
Number of Images	1 to 60	Determines how many still images will be taken when the capture time is reached
Image Interval	1 to 60	If the number of images (above parameter) is greater than 1, this parameter is the time spacing between images
Capture to Memory Card	* CARD * No	Selecting CARD enables the still images taken to be stored to the memory card
Maximum Memory Size	0 to 65535	This is the allowable space on the memory card that will be reserved for Still Images taken by the Self-Timed Capture (in megabytes). A value of 1000 will reserve 1000 Mbytes. A value of 0 has the camera automatically allocate memory.
Management Type Options	* Fill and Stop * Ring Memory	There are 2 methods of managing files on the memory card: * Fill and Stop will stop recording additional images once the memory card is full or the allocated memory size is reached * Ring memory management will start deleting the oldest files once the memory card is full or the allocated memory size is reached
Still Image Settings	* Setting #1 * Setting #2	Still images for this Self-Timed Capture can use 1 of 2 settings. Settings #1 and #2 can be setup with various banner, resolution and compression values. Refer to Section 7.8
Main Folder Name	Read Only Field	This is a read only field. The Name of the Main Folder where the still image files will be stored (SelfTimed1Still)
Sub Folder Options	* Year_Month_Day_Taken * Year_Month_Taken	An option is given to store images in a subfolder named by Year_Month or Year_Month_Day. Selecting the Year_Month_Day option has some performance advantages when a large number of images are taken. Reducing the number of files in a folder speeds up the storing and file management process. Speed advantages are only noticeable if the number of files in the Year_Month folder will exceed 1000
Send via email	* Disabled * EMAIL Settings #1 * * EMAIL Settings #2	Selecting one of the EMAIL settings enables the camera to transmit the still images via EMAIL. The selected EMAIL settings should be properly configured before using the option
Email Still Image Settings	* Setting #1 * Setting #2	One of the two Still Image Settings can be used for the still images that are sent using the FTP

CC5MPX Digital Camera

Send via FTP	* Disabled * FTP Setting #1 * FTP Setting #2	Selecting one of the FTP settings enables the camera to transmit the still images to an FTP server. The selected FTP settings should be properly configured before using the option
FTP Still Image Settings	* Setting #1 * Setting #2	One of the two Still Image Settings can be used for the still images that are sent using FTP
Send via PakBus	* Disabled * Enabled	Used to enable the still images to be sent to PakBus compatible device. The PakBus settings should be properly configured in the Communications Page before enabling this option
PakBus Still Image Settings	* Setting #1 * Setting #2	One of the two still image settings can be used for the still images that are sent using FTP
Video Capture	* Yes * No	Select Yes to include Video Capturing
Video Settings	* Setting #1 * Setting #2	One of two video settings can be used for video capture
Duration in Seconds	0 to 60	The length of time the video is recorded for
Capture to Memory Card	* CARD * No	Selecting CARD enables the video taken to be stored to the memory card
Maximum Memory Card	0 to 65535	This is the allowable space on the memory card that will be reserved for videos taken by the Self-Timed Capture (in megabytes). A value of 1000 will reserve 1000 Mbytes. A value of 0 has the camera automatically allocate memory
Management Type Options	* Fill and Stop * Ring Memory	There are 2 methods of managing files on the memory card: * Fill and Stop will stop recording additional images once the memory card is full or the allocated memory size is reached * Ring memory management will start deleting the oldest files once the memory card is full or the allocated memory size is reached
Main Folder Name	Read Only Field	This is a read only field. The Name of the Main Folder where the still image files will be stored (SelfTimed1Video).
Sub Folder Options	* Year_Month_Day_Taken * Year_Month_Taken	An option is given to store Videos in a subfolder named by Year_Month or Year_Month_Day. Selecting the Year_Month_Day option has some performance advantages when a large number of Videos are taken. Reducing the number of files in a folder speeds up the storing and file management process. Speed advantages are only noticeable if the number of files in the Year_Month folder will exceed 1000.
Send via Email	* Disabled * EMAIL Settings#1 * EMAIL Settings#2	Selecting one of the EMAIL Settings enables the camera to transmit the video files via EMAIL. The selected EMAIL Settings should be properly configured before using the option.
Send via FTP	* Disabled * FTP Settings#1 * FTP Settings#2	Selecting one of the FTP Settings enables the camera to transmit the video files to an FTP server. The selected FTP Settings should be properly configured before using the option.
Send via PakBus	* Disabled * Enabled	Used to enable the video files to be sent to PakBus compatible device. The PakBus settings should be properly configured in the Communications Page before enabling this option

### 7.7.3 Self-Timed Capture2

The settings and parameters are the same as Self-Timed Capture1. Refer to the previous section (7.6.2).

### 7.7.4 External Trigger

The External Trigger Sub Tab (see Figure 7-31) is used to configure the camera to capture still images or video using an external signal that is applied to the External Trigger input line.

The External Trigger can be configured for an active HIGH signal or an active LOW signal (see Section 7.3.5). The capture is triggered by the transition from the inactive state to the active state. The minimum required pulse period is 10msec. Preferably pulses should be short in duration (only a few seconds). The voltage levels are:

- Low Level: <0.65 V (-20 VDC Absolute Min)
- High Level: >2.0 VDC (+20 VDC Absolute Max)

Leaving the signal on the External Trigger in the active state will prevent the camera from entering into a low powered state. If an external device is allowed to keep the camera in its Fully On State, power consumption will be greatly affected.

When the camera is fully on and no other process is taking place, the time from the transition of the signal from inactive to active, to the time a picture is captured or video is started, is typically less than 100msec. The description of the parameters for the External Trigger setup is outlined in Table 7-9 External Trigger Variables.

#### 7.7.4.1 File Transfer Queuing

When performing multiple captures and transfers off the camera in rapid succession the camera will queue file transfers (i.e. send via FTP, then SMTP, then PakBus). File queuing separates the transfer functions from image and video capture.

The camera can capture up to 5 images or videos in parallel with the file transfers all taking place at the same time. For this feature to work an SD card must be present.

#### 7.7.4.2 External Trigger Video Pre-Recording

Video pre-recording allows the camera to record up to 30 seconds of video leading up to a related trigger event. This feature can only be used with external trigger and motion detection capture events.

The external trigger configuration page includes an option labeled **Pre-Record In Seconds**. By entering a value between 1 and 30 in this field the CC5MPX will begin buffering video in its internal memory. When an event occurs, the CC5MPX will store the set number of seconds of video to file and then continue recording the live video until the number of seconds has elapsed.

The use of pre-recording does impose some limitations on the functionality available in the CC5MPX:

- The pre-recording feature can only be used when the camera is in the **Fully On** power mode.

- If the text banner is enabled in the Video Settings used as part of Pre-Record configuration, the text banner will be visible in the Live Video view on the webpage.
- If both image capture and video pre-recording are configured for the same event, the video recording will take precedence. Only once the video has been recorded and saved or transferred from the camera will the image capture occur.

Figure 7-31 External Trigger Setup Page

Table 7-8 External Trigger Variables		
Variable	Allowable Values	Description
External Trigger Enable	* Enable * Disable	Enables or Disables External Trigger Capture
Still Image Capture	* Yes * No	Select Yes to include still image captures
Number of Images	1 to 60	Determines how many still images will be taken when the External Trigger is activated
Image Interval	1 to 60	If the Number of Images (above parameter) is greater than 1, this parameter is the time spacing between images



Capture to Memory Card	* CARD * No	Selecting CARD enables the still images taken to be stored to the memory card
Maximum Memory Size	0 to 65535	This is the allowable space on the memory card that will be reserved for Still Images taken by the Self-Timed Capture (in megabytes). A value of 1000 will reserve 1000 Mbytes. A value of 0 has the camera automatically allocate memory.
Management Type Options	* Fill and Stop * Ring Memory	There are 2 methods of managing files on the memory card: * Fill and Stop will stop recording additional images once the memory card is full or the allocated memory size is reached * Ring memory management will start deleting the oldest files once the memory card is full or the allocated memory size is reached
Still Image Settings	* Setting #1 * Setting #2	Still images for this Self-Timed Capture can use 1 of 2 settings. Settings #1 and #2 can be setup with various banner, resolution and compression values. Refer to Section 7.8
Main Folder Name	Read Only Field	This is a read only field. The Name of the Main Folder where the still image files will be stored (SelfTimed1Still)
Sub Folder Options	* Year_Month_Day_Taken * Year_Month_Taken	An option is given to store images in a subfolder named by Year_Month or Year_Month_Day. Selecting the Year_Month_Day option has some performance advantages when a large number of images are taken. Reducing the number of files in a folder speeds up the storing and file management process. Speed advantages are only noticeable if the number of files in the Year_Month folder will exceed 1000.
Send via email	* Disabled * EMAIL Settings #1 * EMAIL Settings #2	Selecting one of the EMAIL settings enables the camera to transmit the still images via EMAIL. The selected EMAIL settings should be properly configured before using the option
Email Still Image Settings	* Setting #1 * Setting #2	One of the two Still Image Settings can be used for the still images that are sent using the EMAIL
Send via FTP	* Disabled * FTP Setting #1 * FTP Setting #2	Selecting one of the FTP settings enables the camera to transmit the still images to an FTP server. The selected FTP settings should be properly configured before using the option
FTP Still Image Settings	* Setting #1 * Setting #2	One of the two Still Image Settings can be used for the still images that are sent using FTP
Send via PakBus	* Disabled * Enabled	Used to enable the still images to be sent to PakBus compatible device. The PakBus settings should be properly configured in the Communications Page before enabling this option
PakBus Still Image Settings	* Setting #1 * Setting #2	One of the two still image settings can be used for the still images that are sent using FTP
Video Capture	* Yes * No	Select Yes to include Video Capturing
Video Settings	* Setting #1 * Setting #2	One of two video settings can be used for video capture

CC5MPX Digital Camera

Duration in Seconds	0 to 60	The length of time the video is recorded
Pre-Record in Seconds	0 to 30	The length of time the video is recorded prior to the external trigger event. This interval is a portion of the 'Duration in Seconds' interval. It is not in addition to the 'Duration in Seconds' interval
Capture to Memory Card	* CARD * No	Selecting CARD enables the video taken to be stored to the memory card
Maximum Memory Size	0 to 65535	This is the allowable space on the memory card that will be reserved for videos taken by this External Trigger Capture (in megabytes). A value of 1000 reserves 1000 Mbytes. A value of 0 has the camera automatically allocate memory.
Management Type Options	* Fill and Stop * Ring Memory	There are 2 methods of managing files on the memory card: * Fill and Stop will stop recording additional video once the memory card is full or the allocated memory size is reached * Ring memory management will start deleting the oldest files once the memory card is full or the allocated memory size is reached
Main Folder Name	Read Only Field	This is a read only field. The Name of the Main Folder where the still image files will be stored (ExternTrig1Video).
Sub Folder Options	* Year_Month_Day_Taken * Year_Month_Taken	An option is given to store videos in a subfolder named by Year_Month or Year_Month_Day. Selecting the Year_Month_Day option has some performance advantages when a large number of videos are taken. Reducing the number of files in a folder speeds up the storing and file management process. Speed advantages are only noticeable if the number of files in the Year_Month folder will exceed 1000. If speed is not an issue, then user preference is fine.
Send via Email	* Disabled * EMAIL Settings#1 * EMAIL Settings#2	Selecting one of the EMAIL Settings enables the camera to transmit the video files via EMAIL. The selected EMAIL Settings should be properly configured before using the option.
Send via FTP	* Disabled * FTP Settings#1 * FTP Settings#2	Selecting one of the FTP Settings enables the camera to transmit the video files to an FTP server. The selected FTP Settings should be properly configured before using the option.
Send via PakBus	* Disabled * Enabled	Used to enable the video files to be sent to PakBus compatible device. The PakBus settings should be properly configured in the Communications Page before enabling this option.

## 7.7.5 Motion Detection

The Motion Detection Sub Tab (see Figure 6) is used to configure the camera to capture still images or video using the Motion Detection capability of the camera.

Even if this feature is enabled, the motion detection will only operate when the camera is in the Fully On power state.

Figure 7-32 Motion Detection Page

### 7.7.5.1 CC5MPX Motion Detection Description

The CC5MPX camera implements an adaptive motion detection scheme in order to help avoid false motion detection triggers that can occur in normal outdoor scenes. The adaptive motion detection method automatically adjusts the motion detection threshold based on the average motion characteristics of a given scene.

The adaptive motion detection scheme sets its threshold values based on a 20 second moving average of the scene. For example, if a CC5MPX was focused on a

ceiling fan that was off the CC5MPX motion detection would be triggered if the fan was turned on. After a period of 20 seconds the motion detection would no longer be triggered as the continuous motion of the fan would automatically increase the required motion detection trigger level.

The sensitivity level for motion detection is the only user configurable parameter for Motion Detection operation. A value of 1 provides the least sensitive motion detect threshold setting and a value of 99 provides the most sensitive motion detect threshold setting. Motion detection can be a complicated feature to implement. It is recommended to start off with a motion detect threshold setting of 50 and experiment with the performance based on your application.

If the camera is not detecting motion that is desired, then the motion detection sensitivity level should be increased. If the camera is producing too many false triggers, then the motion detect level should be decreased. Note that there is always a probability that the camera can either produce false motion detects or not detect desirable motion due to too many scene variables. In some cases where motion detection of a small object is required, it may be necessary to set a motion detect level that will also produce frequent false triggers.

The adaptive motion detect is a very good method for most applications. One consideration is that when a continuous level of motion is introduced into a scene the motion detection sensitivity decreases. The result is that some motion may not be detected when a continuous dynamic scene exists. For example, a person walking through a scene with windblown trees may not trigger the motion detect capture that would normally be triggered when there is no wind and the trees are not moving.

#### **Motion Detection Notes:**

- If a moving object that requires detection occupies a larger percentage of the image scene, the motion detection tends to be more reliable. Zooming in or moving the camera closer to the moving objects helps improve performance.
- Objects moving slowly within the image scene require a higher sensitivity setting compared to fast moving objects.
- Sudden changing light levels can falsely trigger motion detection. Sources of false triggers include rapidly changing light levels at sunrise or sunset, or during the movement of clouds.
- Good lighting of the image scene produces the best results.
- The motion detection feature uses the full 4:3 ratio frame to capture motion. Still images in the 320 x 176, 640 x 352 and 1280 x 720 formats, and video in the 720p format will crop a portion of the top and bottom of the image or video.
- Motion detection is paused when video is being recorded.
- The delay from motion occurring to image capture is typically 1 second (2 seconds for a 5MP image).

#### **7.7.5.2 Motion Detection Video Pre-Recording**

Video pre-recording allows the camera to record up to 30 seconds of video leading up to a related trigger event. This feature can only be used with the external trigger and motion detection capture events.

The Motion Detection configuration page includes an option labeled ***Pre-Record In Seconds***. By entering a value between 1 and 30 in this field, the CC5MPX will begin buffering video in its internal memory. When an event occurs, the CC5MPX stores a set number of seconds of video to file and then continues recording the live video until the number of seconds of duration has elapsed.

The use of pre-recording does impose some limitations on the functionality available in the CC5MPX:

- The pre-recording feature can only be used when the camera is in the **Fully On** power mode.
- If the text banner is enabled in the Video Settings used as part of Pre-Record configuration, the text banner will be visible in the Live Video view on the webpage.
- If both image capture and video pre-recording are configured for the same event, the video recording will take precedence. Only once the video has been recorded and saved or transferred from the camera will the image capture occur.

**Table 7-9 Motion Detection Settings**

Variable	Allowable Values	Description
Sensitivity Level	1 to 99	The best method for determining where to set the level for your needs is to experiment with the values. The Value of 1 is the least sensitive value but less prone to false triggers. The Value of 99 is the most sensitive value, and is most susceptible to false triggers.  You do not need to enable the motion detection to test its functionality. Simply set this parameter and observe the Motion Detect Status in the Live Video page.
Motion Detection Enable	* Enable * Disable	Enables or Disables Motion Detection Captures.
Start Minutes	0 to 1439	Start time in minutes relative to Midnight. The Motion Detection can be set to be active for a certain time period only. See Table 7-6 Start and Stop Time Examples for more details.
Stop Minutes	0 to 1439	Stop time in minutes relative to Midnight. The Motion Detection can be set to be active for a certain time period only. See Table 7-6 Start and Stop Time Examples for more details.
Still Image Capture	* Yes * No	Select Yes to include still image captures.
Number of Images	1 to 60	Determines how many still images will be taken when the Motion Detection is activated.
Image Interval	1 to 60	If the Number of Images (above parameter) is greater than 1, this parameter is the time spacing between images.
Capture to Memory Card	* CARD * No	Selecting CARD enables the still images taken to be stored to the memory card.
Maximum Memory Size	0 to 65535	This is the allowable space on the memory card that will be reserved for Still Images taken by Motion Detection capture (in megabytes). A value of 1000 reserves 1000 Mbytes. A value of 0 has the camera automatically allocate the memory.
Management Type Options	* Fill and Stop * Ring Memory	There are 2 methods of managing files on the memory card: * Fill and Stop will stop recording additional images once the memory card is full or the allocated memory size is reached

CC5MPX Digital Camera

		* Ring memory management will start deleting the oldest files once the memory card is full or the allocated memory size is reached
Still Image Settings	* Setting #1 * Setting #2	Still Images for the External Trigger Capture can use 1 of 2 settings. Settings #1 and Settings #2 can be setup with various banner, resolution and compression values.
Main Folder Name	Read Only Field	This is a read only field. The Name of the Main Folder where the still image files will be stored (MotionDetectStill).
Sub Folder Options	* Year_Month_Day_Taken * Year_Month_Taken	An option is given to store images in a subfolder named by Year_Month or Year_Month_Day. Selecting the Year_Month_Day option has some performance advantages when a large number of images are taken. Reducing the number of files in a folder speeds up the storing and file management process. Speed advantages are only noticeable if the number of files in the Year_Month folder will exceed 1000.
Send via Email	* Disabled * EMAIL Settings #1 * EMAIL Settings #2	Selecting one of the EMAIL settings enables the camera to transmit the still images via EMAIL. The selected EMAIL settings should be properly configured before using the option
Email Still Image Settings	* Setting #1 * Setting #2	One of two still image settings can be used for the still images that are sent using EMAIL.
Send via FTP	* Disabled * FTP Settings #1 * FTP Settings #2	Selecting one of the FTP Settings enables the camera to transmit the still images to an FTP server. The selected FTP Settings should be properly configured before using the option.
FTP Still Image Settings	* Setting #1 * Setting #2	One of the two Still Image Settings can be used for the still images that are sent using FTP
Send via PakBus	* Disabled * Enabled	Used to enable the still images to be sent to PakBus compatible device. The PakBus settings should be properly configured in the Communications Page before enabling this option
PakBus Still Image Settings	* Setting #1 * Setting #2	One of the two still image settings can be used for the still images that are sent using FTP
Video Capture	* Yes * No	Select Yes to include Video Capturing
Video Settings	* Setting #1 * Setting #2	One of two video settings can be used for video capture
Duration in Seconds	0 to 60	The length of time the video is recorded
Pre-Record in Seconds	0 to 30	The length of time the video is recorded prior to the external trigger event. This interval is a portion of the 'Duration in Seconds' interval. It is not in addition to the 'Duration in Seconds' interval
Capture to Memory Card	* CARD * No	Selecting CARD enables the video taken to be stored to the memory card.
Maximum Memory Size	0 to 65535	This is the allowable space on the memory card that will be reserved for video taken by Motion Detection capture (in megabytes). A value

		of 1000 reserves 1000 Mbytes. A value of 0 has the camera automatically allocate the memory.
Management Type Options	* Fill and Stop * Ring Memory	There are 2 methods of managing files on the memory card: * Fill and Stop will stop recording additional video once the memory card is full or the allocated memory size is reached * Ring memory management will start deleting the oldest files once the memory card is full or the allocated memory size is reached
Main Folder Name	Read Only Field	This is a read only field. The Name of the Main Folder where the video files will be stored (MotionDetectVideo).
Sub Folder Options	* Year_Month_Day_Taken * Year_Month_Taken	An option is given to store Video in a subfolder named by Year_Month or Year_Month_Day. Selecting the Year_Month_Day option has some performance advantages when a large number of Videos are taken. Reducing the number of files in a folder speeds up the storing and file management process. Speed advantages are only noticeable if the number of files in the Year_Month folder will exceed 1000. If speed is not an issue, then user preference is fine.
Send via Email	* Disabled * EMAIL Settings#1 * EMAIL Settings#2	Selecting one of the EMAIL Settings enables the camera to transmit the video files via EMAIL. The selected EMAIL Settings should be properly configured before using the option.
Send via FTP	* Disabled * FTP Settings#1 * FTP Settings#2	Selecting one of the FTP Settings enables the camera to transmit the video files to an FTP server. The selected FTP Settings should be properly configured before using the option.
Send via PakBus	* Disabled * Enabled	Used to enable the video files to be sent to PakBus compatible device. The PakBus settings should be properly configured in the Communications Page before enabling this option

## 7.7.6 Save/Read Camera Settings

This feature allows for configuration settings to be saved or loaded via the web interface. The .xml configuration files are also compatible with the Device Configuration Utility.

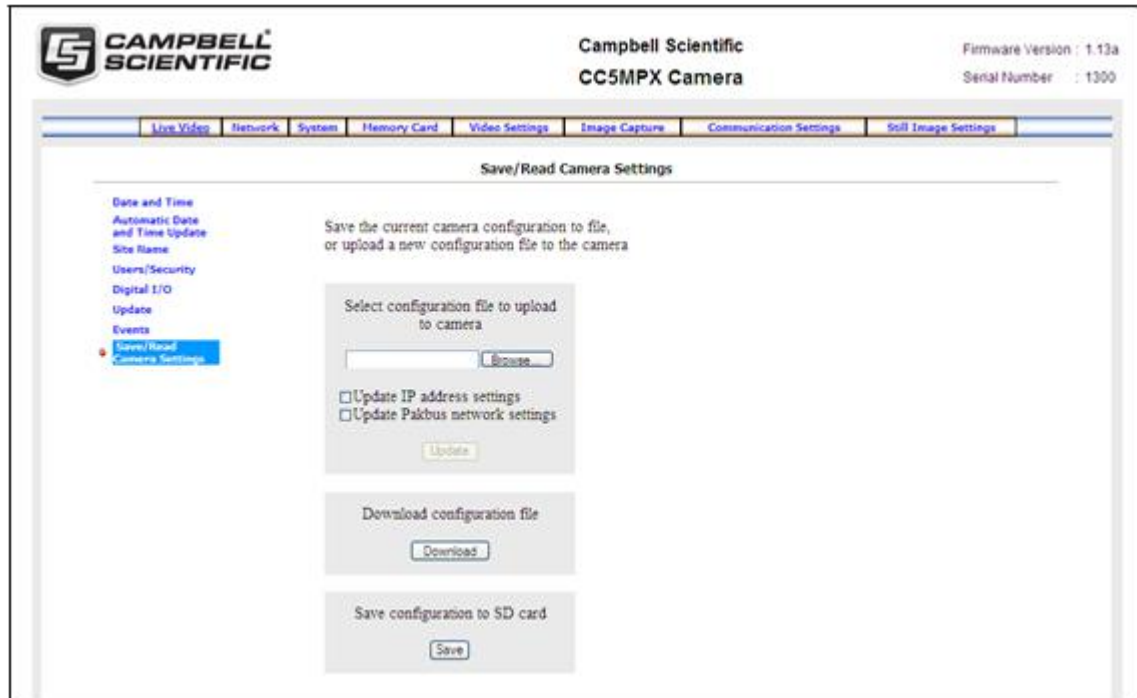

Figure 7-33 Save/Read Camera Settings

## 7.8 PakBus Communication Settings

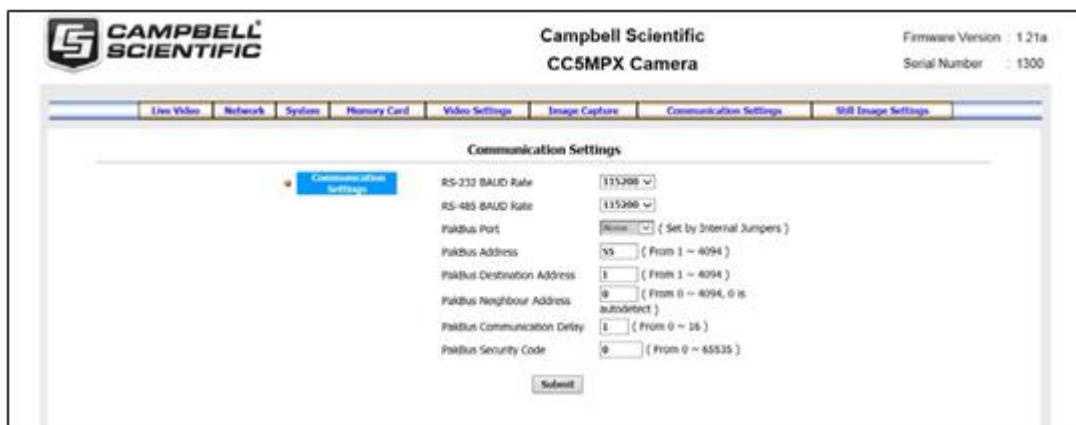

Figure 7-34 Communication Settings Page

Communications using the PakBus protocol enables remote retrieval and/or storage of images or video to external devices such as compatible Campbell Scientific dataloggers. The factory default communication interface is RS-232. If RS-485 is required, the internal camera jumpers will need to be changed. See Section 8 for more details.



Additionally, the PakBus neighbouring address allows for communication with devices that are several hops away on the PakBus network. See TABLE 7-11 for reference.

**Table 7-10 PakBus Communication Settings**

Variable	Allowable Values	Description
RS-232 BAUD Rate	* 115200 * 57600 * 38400 * 19200 * 9600	Select the desired BAUD rate. Once the BAUD rate is set, it will always be fixed. The factory Default Settings is 115200 BAUD.
RS-485 BAUD Rate	* 115200 * 57600 * 38400 * 19200 * 9600	Select the desired BAUD rate. Once the BAUD rate is set, it will always be fixed. The factory Default Settings is 115200 BAUD.
PakBus Port	Read Only	The value reflects the internal jumper settings of the camera. It will either read RS-232 or RS-485. See Section 8 Internal Jumpers, if the jumpers need to be changed.
PakBus Address	1 to 4094	The desired PakBus address for this camera. The factory default is 55.
PakBus Destination Address	1 to 4094	The PakBus address of the device the camera will communicate with or send files to.
PakBus Neighbour Address	0 to 4094	Enter the address of the PakBus device physically to connect to the CC5MPX PakBus communication lines. This allows the neighbor to relay communication between the CC5MPX and the final destination for the data.
PakBus Communication Delay	0 to 16	Extra delays may be required for certain communication links, such as satellite.
PakBus Security Code	0 to 65535	The factory default is 0. If a security code is not required by the PakBus destination device, set this parameter to 0. Otherwise set the security code as required by the destination service.

## 7.9 Still Images

Selecting the Still Image settings tab brings up the Still Image settings page (see Figure 7-35). The Still Image settings allows for the configuration of still images that the camera will take/

There are 2 Sub Tabs that include 2 independent Still Settings:

- Still Settings #1
- Still Settings #2

Table 7-12 Still Image Settings describes the variables used in the Still Image settings.

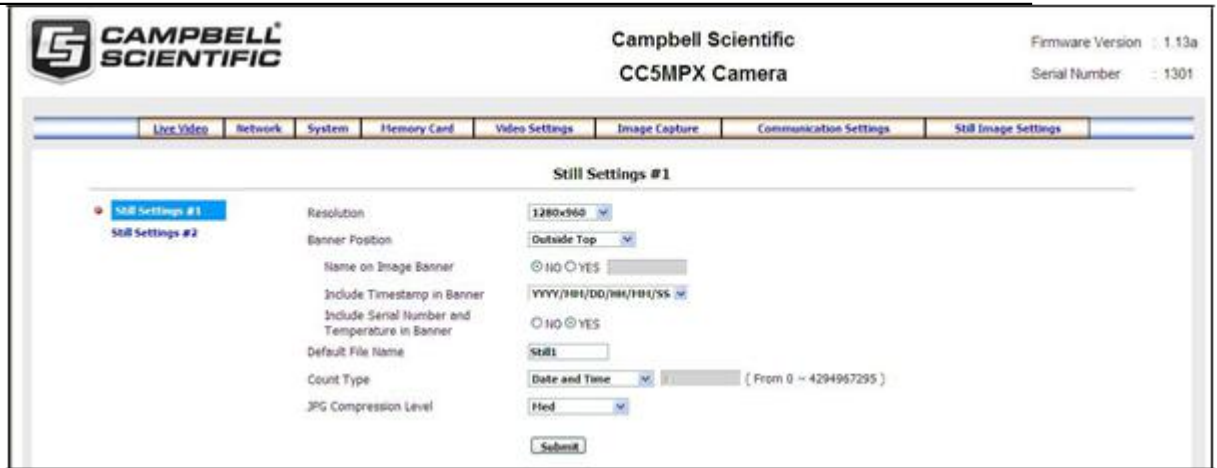

Figure 7-35 Still Images Settings Page

Variable	Allowable Values	Description
Resolution	<ul style="list-style-type: none"> <li>* 320 x 176</li> <li>* 320 x 240</li> <li>* 640 x 352</li> <li>* 640 x 485</li> <li>* 1280 x 720</li> <li>* 1280 x 960</li> <li>* 2592 x 1944</li> </ul>	The resolution option is the resolution of the Still Image in pixels (width x height)
Banner Position	<ul style="list-style-type: none"> <li>* OFF</li> <li>* Inside Top</li> <li>* Inside Bottom</li> <li>* Outside Top</li> <li>* Outside Bottom</li> </ul>	<p>Selecting the Inside banner displays the text within the image area either at the top or bottom.</p> <p>The Outside banner is a text bar placed above or below the still image. The vertical height of the picture is increased to accommodate the Outside banner. See Table 7-13 Still Image Resolution Details for the image sizes with Outside banners.</p>
Name on Image Banner	<ul style="list-style-type: none"> <li>* NO</li> <li>* YES</li> </ul>	By selecting Yes, a custom name can be placed on the Image Banner. Refer to Section 11 for details on how to alter the Banner via a PakBus datalogger. See Table 7-13 Still Image Resolution Details for the number of characters that can fit on a specific resolution size. The Actual Text field can hold 255 characters.
Include Timestamp in Banner	<ul style="list-style-type: none"> <li>* NONE</li> <li>* YYYY/MM/DD/HH/MM/SS</li> <li>*MM/DD/YYYY</li> <li>HH:MM:SS</li> <li>*MM/DD/YYYY HH:MM</li> <li>*MM/DD/YYYY</li> </ul>	A timestamp can be placed on the banner, there are several options for the format of the date and time to be printed on the image. For example, the YYYY/MM/DD HH:MM:SS setting would print a date as: 2014/01/30/ 14:54:07
Default File Name	Text Field	This text field allows a file name to be used for the still images produced. The text is limited to 32 characters.

Count Type	<ul style="list-style-type: none"> <li>* NONE</li> <li>* Date and Time</li> <li>* Number Increment</li> </ul>	<ul style="list-style-type: none"> <li>* The NONE option uses the same file name for all pictures. Only 1 image name appears in a directory or is transmitted out (EMAIL, FTP, or PakBus)</li> <li>* The Date and Time option appends a timestamp to the file name, The text entered in the above parameter (Default File Name) is followed by the date and time: &lt;Default File Name&gt;_YYYY_MM_DD_HH_MM_SS.jpg</li> <li>* The Number Increment option appends a 10 digit counter to the file name. The files are named with the following format after the Default File Name text: &lt;Default File Name&gt;_XXXXXXXXXX.jpg</li> </ul>
JPG Compression Level	<ul style="list-style-type: none"> <li>* NONE/Lossless</li> <li>* Low</li> <li>* Med</li> <li>* High</li> <li>* Very High</li> </ul>	<p>The None/Lossless compression level produces the largest JPEG files with no loss of information. The Very High compression level produces the smallest file sizes, but there will be noticeable distortions in the picture due to compression. See Table 7-13 Still Image Resolution Details for typical size information.</p>

Table 7-12 Still Image Resolution Details				
Resolution	Size with Outside Banner	Maximum Characters in Banner	Compression Type	Typical File Size
320 x 176	320 x 192	45	None/Lossless	32
			Low	16
			Medium	12
			High	8
			Very High	6
320 x 240	320 x 256	45	None/Lossless	40
			Low	20
			Medium	15
			High	10
			Very High	8
640 x 352	640 x 384	64	None/Lossless	120
			Low	40
			Medium	28
			High	20
			Very High	16
640 x 480	640 x 512	64	None/Lossless	132
			Low	48
			Medium	32
			High	25

			Very High	18
1280 x 720	1280 x 752	98	None/Lossless	448
			Low	128
			Medium	75
			High	54
			Very High	40
1280 x 960	1280 x 992	98	None/Lossless	580
			Low	164
			Medium	96
			High	68
			Very High	48
2592 x 1944	2592 x 1984	136	None/Lossless	1900
			Low	500
			Medium	264
			High	190
			Very High	150

## 7.9.1 GPS Coordinates

GPS coordinates (*CC5MPXGPSLatitude* and *CC5MPXGPSLongitude*) can be embedded in the image or video files that the camera generates. 2 PakBus variables allow the logger to send the GPS coordinates to the camera, where they are embedded in the images or video.

The GPS coordinates must be sent as floating point values. Positive latitude and longitude represent northern and eastern hemispheres, respectively. While negative values represent southern and western hemispheres, respectively. Values are not saved through a power cycle, or in off-mode, but do not need to be updated every time an image or video is sent.

### 7.9.1.1 Example Program – Adding GPS Coordinates to Image Banner

The following example illustrates the use of the *CC5MPXGPSLatitude* and *CC5MPXGPSLongitude* instructions, which can be used with CR800 series, CR1000, or CR3000 dataloggers.

```
Public sendGps As Boolean Public gpsLat, gpsLong As Float public sendVarResult
BeginProg
sendGps = false
gpsLat = 50.0
gpsLong = -139.0
SerialOpen (Com1,115200,4,0,2000)

Scan (1,Sec,0,0) If sendGps Then sendGps = false SendVariables
(sendVarResult,Com1,0,55,0000,0,"Public","CC5MPXGPSLatitude",gpsLat, 1)
SendVariables (sendVarResult,Com1,0,55,0000,0,"Public","CC5MPXGPSLongitude",gpsLong,
1)
EndIf
NextScan EndProg
```

## 8. Internal Jumpers

There are 2 sets of jumpers that are internal to the camera. 1 set is used to select either RS-232 or RS-485 communications on the Power I/O cable. The other set is used to select a pull up or a pull down resistor on the External Trigger input line.

Refer to Section 20 for details to remove the backplate to access the internal jumpers of the camera.

### 8.1 RS-232/RS-485 Jumpers

Jumper locations are shown in Figure 7. There are 3 jumpers that can be moved from either the left or the right 2 x 3 jumper posts. When the jumpers are on the right 2 x 3 jumper posts then the RS-232 output is selected (Factory Default position). To change the serial output format from RS-232 to RS-485 move all 3 jumpers from the right to the 2 x 3 jumper posts located on the left position. Always move all 3 jumpers and never install additional jumpers.

The available communication interfaces can be configured with the cameras web interface or via the Device Configuration Utility. RS-232 and RS-485 interfaces can be configured to a range of baud rates between 9600 and 115200 baud. Both interfaces support only the PakBus protocol.

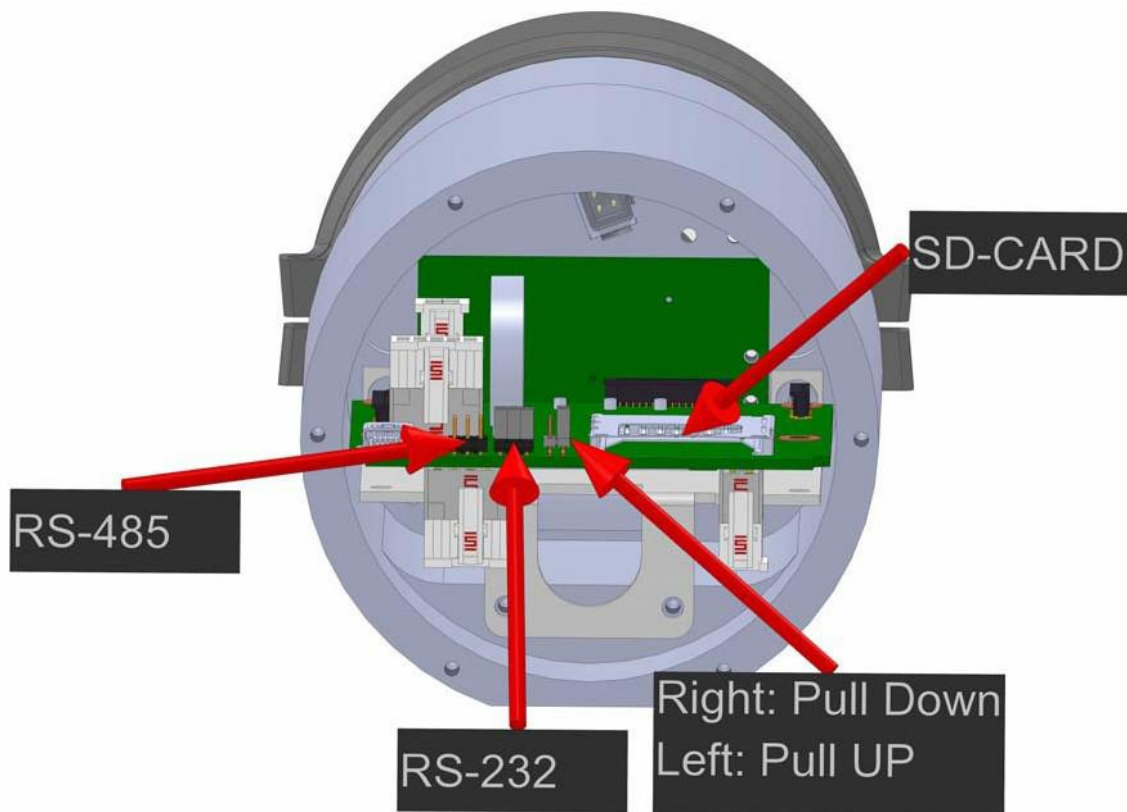

Figure 8-1 Internal Jumper Locations

### 8.2 External Trigger Pull-up/Pull-down Jumper

The jumper location for the External Pull-up/Pull-down location is shown in Figure 7. When the jumper is located on the right 2 pins of the header (factory default

position) there is a 100 KOhm pull-down resistor connected from the External Trigger line to ground. When the jumper is placed on the left 2 pins of the header there is a 47K pull-up resistor connected from the External Trigger line to 3.3 Volts.

The pull-up resistor would be useful for having contact closures or open collector output signals trigger the camera. In the case of a contact closure the jumper would be moved to the pull-up position and then 1 end of the contact would connect to the External Trigger signal and the other end of the contact would connect to ground. A schematic representation is shown in Figure 8-2.

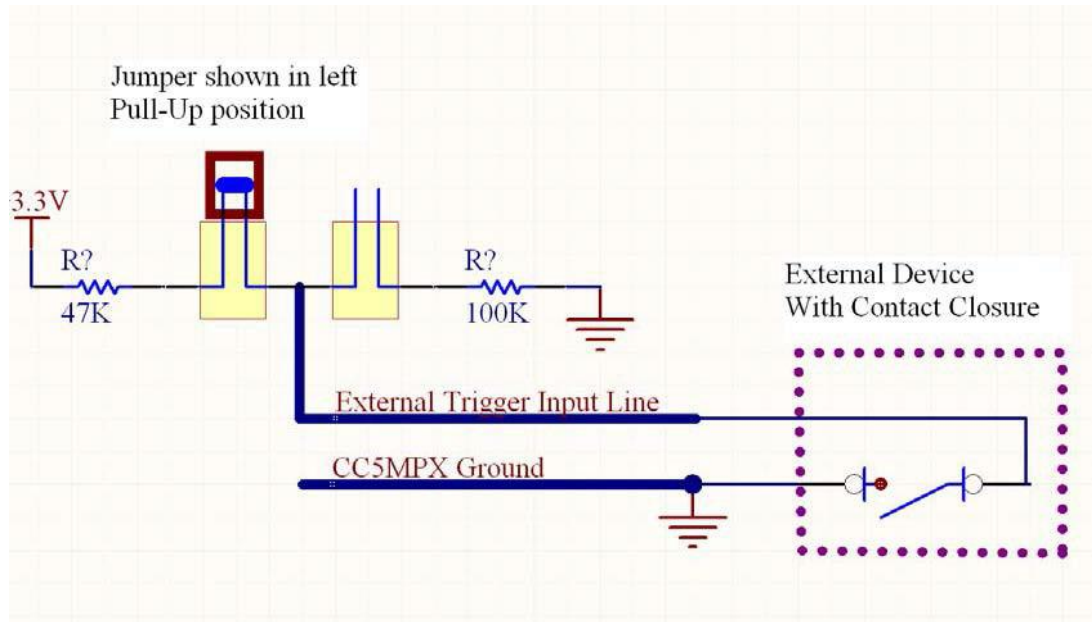
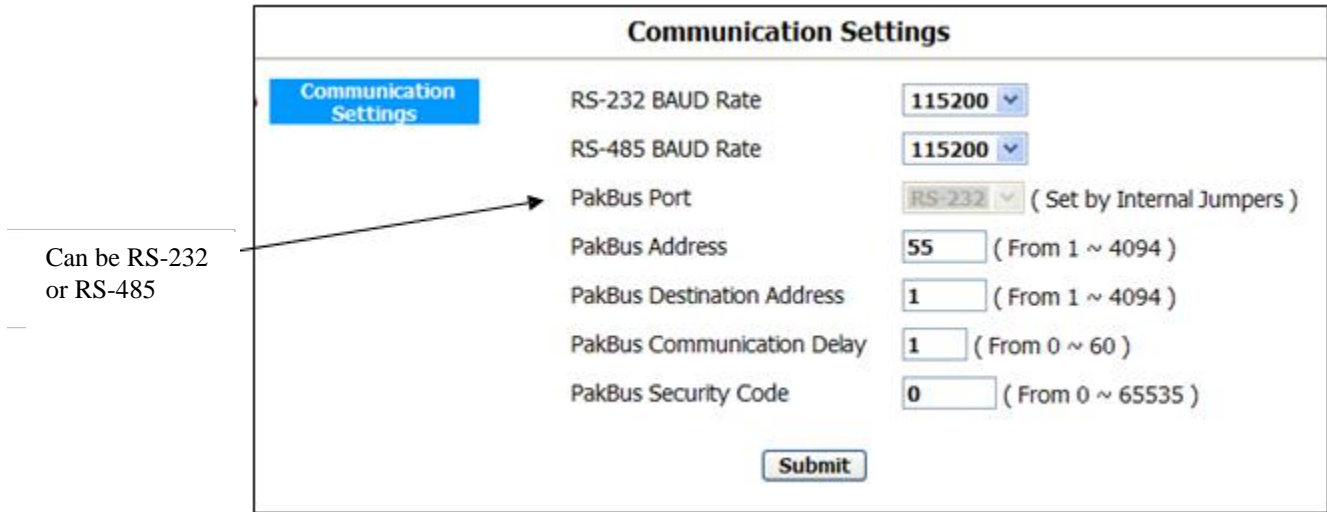

Figure 8-2 Schematic Showing External Contact Device

## 9. RS-232 Communications

The RS-232 serial communications are used with the camera for two purposes: to configure and setup the camera using Device Configuration Utility software that Campbell Scientific provides; to send image files from the camera to other devices using the PakBus protocol.

Check the PakBus port value under the Communications Setting if you are not sure that your camera has internal jumpers configured to RS-232 or RS-485 (see Figure 9-1).



**Figure 9-1 Serial PakBus Port Setting**

The CC5MPX Power I/O port is configured by default to provide a 3-wire RS-232 connection (Tx, Rx, Ground). The wires can be terminated directly on the control ports of a compatible datalogger. For connection to a computer 9 pin serial port, use the DB9 FEMALE to Terminal Block Adaptor, which facilitates the connection of the Cable Pigtail end to a computer 9-pin serial port. The adaptor comes with the CC5MPX as an accessory. See Figure 9-2.

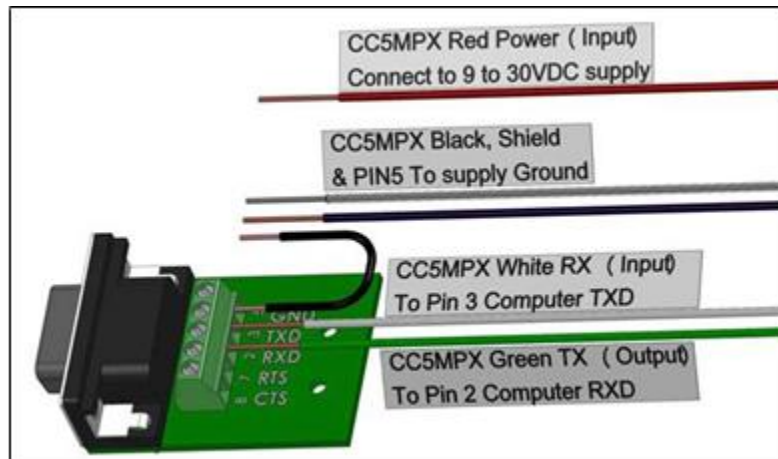

**Figure 9-2 Connecting the CC5MPX to a 9 Pin RS-232 Port**

An illustration of the required RS-232 connections to a datalogger is shown in Figure 9-3.

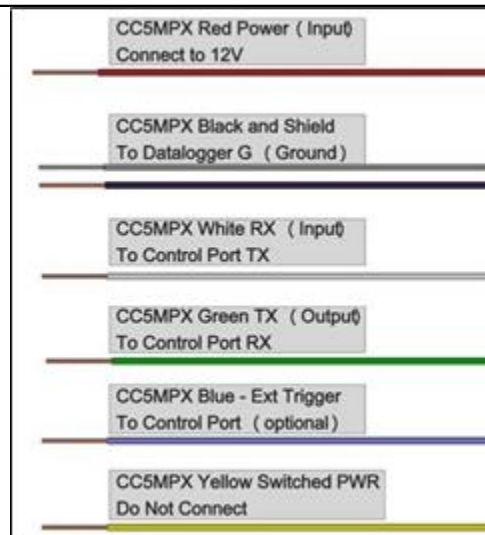

Figure 9-3 Datalogger Connections with RS-232

## 10. RS-485 Communications

The optional RS-485 communication interface of the CC5MPX can be used in conjunction with the MD485 to interface a datalogger to 1 or more cameras. Refer to the MD485 Manual for additional information.

The MD485 is useful for connecting more than 1 camera to a datalogger or if long cable lengths are involved. If multiple cameras are connected to an MD485, then it would be beneficial to offset the capture times of the images so that only 1 camera is attempting to transmit a file at any given time.

The camera can download images or video via an RS-485 port using the PakBus protocol. An MD485 is required to interface the camera to a datalogger. The following items are required for RS-485 PakBus communications and can be confirmed by either the web interface of the Device Configuration Utility:

- Confirm that the PakBus port parameter of the Communications Setting is reading RS-485.
- Set the RS-485 BAUD rate to match the BAUD rate of the device being connected to the camera.
- Set the parameter PakBus Address of Communication Settings to a unique value in the PakBus network.
- Set the parameter PakBus Destination Address of the device that the camera needs to send images to.
- Include PakBus Security Code, as required.



Communication Settings		
<div style="border: 1px solid black; padding: 2px; display: inline-block; background-color: #007bff; color: white; border-radius: 3px;">Communication Settings</div>	RS-232 BAUD Rate	<input type="text" value="115200"/> ▾
	RS-485 BAUD Rate	<input type="text" value="115200"/> ▾
	<div style="border: 1px solid black; padding: 2px; display: inline-block;">Set for RS-485</div> <span style="font-size: 2em; vertical-align: middle;">→</span> PakBus Port	<input type="text" value="RS-485"/> ▾ ( Set by Internal Jumpers )
	PakBus Address	<input type="text" value="55"/> ( From 1 ~ 4094 )
	PakBus Destination Address	<input type="text" value="1"/> ( From 1 ~ 4094 )
	PakBus Communication Delay	<input type="text" value="1"/> ( From 0 ~ 60 )
	PakBus Security Code	<input type="text" value="0"/> ( From 0 ~ 65535 )
<input type="button" value="Submit"/>		

Figure 10-1 RS-485 Shown in PakBus Port Setting

## 11. PakBus Communications

The camera uses the PakBus protocol to send image files from the camera to the datalogger or other PakBus compatible devices. The Loggernet Tool PakBus Graph can be used to change the configuration of a camera. The use of the PakBus Graph is discussed in Section 11.2. Refer to the Loggernet literature or software for more details.

PakBus can also be used to control specific operational parameters, transfer variables or text between the datalogger and camera. When an image or video file is ready to be transmitted, the camera will initiate communications and send the image or video via the selected serial interface.

The CC5MPX is capable of producing video files that exceed 30MB in size. Trying to send such a large file to a datalogger using PakBus can be problematic. For this reason, the CC5MPX is setup to not send any files using PakBus that are larger than 2MB.

The camera is a PakBus Lead node and is not capable of performing any routing. However, the CC5MPX has the ability to communicate with devices that are several hops away on the PakBus network.

### 11.1 Concurrent PakBus Communications

PakBus allows the camera to download images to a datalogger simultaneously with other datalogger communications. A communications task will take longer if the datalogger is communicating with multiple devices at the same time.

It may be beneficial to set up the system to avoid image transfers when other communications are scheduled.

For example, longer connect times on long distance telephone connections can be avoided by scheduling image transfers from the camera to the datalogger outside the scheduled data collection time. If a station is called on the hour to retrieve data, image acquisitions could be initiated before the scheduled call (15 minutes prior) to shorten the connect times.

## 11.2 PakBus Graph Operations

The CC5MPX supports configuration via PakBus Graph over the serial port. A logger or other type of PakBus relay device is required to interface PakBus Graph to the camera.

### 11.2.1 Logger Settings

The logger must be configured as a router (i.e. *Is Router* must be set to true) and the camera PakBus address must be in the list of allowed neighbours for the datalogger port used. The camera and the logger must be set to use the same baud rate to communicate properly.

### 11.2.2 Discovery

After starting PakBus graph, the camera may not be visible immediately. To discover the camera, right click on the green box marked as [4094] in the graph and click on Search for Neighbours. This will open the Search for Neighbours dialog box, press the Start button and the graph should display all the devices within the PakBus network.

### 11.2.3 Power Modes

The camera has several low power modes. The CC5MPX cannot respond to PakBus communications while the camera is in the low power state of OFF mode or in Deep Sleep mode. PakBus communications will wake up the camera if it is set for Partially On mode. Using the low power mode with the Ethernet power mode set to Full Power Save will allow the camera to respond almost immediately (less than 10 seconds).

The external trigger can also be utilized to wake up the camera and stop it from entering a low power mode by asserting the external trigger and leaving it high. Lowering the external trigger signal will allow the camera to enter a low powered operating mode again.

## 11.3 PakBus Variable Control

The camera is capable of receiving variables, commands, or text from a datalogger. The specific operational parameters that can be altered or controlled include:

- Still Image Banners
- Video Banners
- Camera Window Defroster
- Camera Shutdown

The use of the “Send Variable” instruction allows the datalogger to transfer values or text that can be used in the image or video banners. The “Send Variable” instruction is used to toggle the camera window defroster on/off, or safely shut the camera down.

To update the Banner information with values from a datalogger the variable is a String, and must be limited to 255 characters (including null terminator).

The camera variable names are:

- CC5MPXStillBanner1

- CC5MPXStillBanner2
- CC5MPXVideoBanner1
- CC5MPXVideoBanner2

The variable for controlling the window defroster is numeric and needs to be declared as a Long in CRBasic. The variable for controlling camera power is a Boolean, which needs to be declared in CRBasic. The names of the camera variables are:

- CC5MPXDefroster
- CC5MPXShutdown

### 11.3.1 PakBus Control of Window Defroster Function

PakBus will temporarily (one shot) override the existing window defroster control state. Users are advised to only use one type of control to avoid unexpected operation of the defroster. Options include the Automatic mode set via the webpage or the DevConfig Utility, or PakBus SendVariables command.

To turn on the defroster, the numeric value should be set to a non-zero value (i.e. 1). To turn the defroster off, the value should be set to zero. When a non-zero value is sent to the camera, the heater will turn on and a 65 second countdown timer will start. After 65 seconds, the defroster will automatically turn off (this should override settings already in place). If an additional non-zero is sent before the defroster is turned off, then the timer will be reset to zero and will begin the countdown again.

The defroster commands should be sent to the camera every 60 seconds or more to ensure continuous operation.

The defroster will be allowed to turn on only once for 65 seconds at internal temperatures between 25°C and 50°C. This flag will only be reset again once the internal temperature drops below 25°C, or the camera is reset. Full, continuous operation is only allowed at temperatures of 25°C or less. At internal temperatures above 50°C, the defroster will not turn on.

### 11.3.2 PakBus Control of CC5MPX Power

The ability to shutdown the camera safely using a PakBus command is available in the CC5MPX. By writing a value of 1 (or any value not equaling zero) to the public Boolean variable “CC5MPXShutdown” the camera initiates a shutdown and power down cleanly. The shutdown process can take up to 30 seconds. The camera will turn back on after 10 minutes, or can be externally triggered.

Following is an example of the CRBasic command that will shut down a camera with PakBus address 55:

```
SendVariables (SendVarResult,Com1,0,55,0000,400, “Public”, “CC5MPXShutdown”,1,1)
```

### 11.3.3 Example Program – SendVariable Instruction

The following example illustrates the use of the “SendVariable” instruction to alter Still Image Banner #2, as well as toggle the camera window defroster.

```

'CR1000 Series Datalogger

'Declare Public Variables
Public PTemp, batt_volt
Public TurnDefrosterOn As Boolean
Public TurnDefrosterVal As Long
Public SendVarResult As Long
Public BannerString As String * 60
Public tempstring As String * 60

'Define Data Tables
  DataTable (Test,1,-1)
  DataInterval (0,60,Sec,10)
  Minimum (1,batt_volt,FP2,0,False)
  Sample (1,PTemp,FP2)
EndTable

'Main Program
BeginProg

SerialOpen (Com1,115200,4,0,2000)

Scan (10,Sec,0,0)
  PanelTemp (PTemp,250)
  Battery (batt_volt)

'Enter other measurement instructions
  tempstring = FormatFloat(PTemp,"%2.2f")
  BannerString = "Panel Temp " + tempstring

  If TimeIntoInterval (0,5,Min) Then
    SendVariables
    (SendVarResult,Com1,0,55,0000,400,"Public","CC5MPXStillBanner2",BannerString,1) EndIf

If TurnDefrosterOn = true Then
  TurnDefrosterVal = 1
  SendVariables
  (SendVarResult,Com1,0,55,0000,200,"Public","CC5MPXDefroster",TurnDefrosterVal,1)
TurnDefrosterOn = false
EndIf

  CallTable Test
NextScan
EndProg

```

## 11.4 PakBus Neighbouring Address

The PakBus protocol allows devices to relay data in a network. The CC5MPX now has the ability to communicate with devices that are several hops away on the PakBus network. To configure this new feature, a setting has been added to the PakBus configuration screen on the webpage.

Entering the address of the PakBus device physically connected to the CC5MPX PakBus communication lines, allows the neighbor to relay communication between the CC5MPX and the final destination for data. Leave PakBus set to zero (0) if device is directly connected to the final destination.

## 12. Device Configuration Utility

The Device Configuration Utility can be used to change settings in the CC5MPX. The Device Configuration Utility software can be downloaded at no charge from the Campbell Scientific website.

**Using the Device Configuration Utility:**

- Connect the camera to the serial port of a PC using the DB9 FEMALE to Terminal Block Adaptor, as shown in Section 9 RS-232 Communications.
- Once the camera is powered up (this can typically take 90 seconds), you should observe that the LED flashes. If the LED does not flash, you may have to press the Setup button to exit the camera from a low powered mode.
- Select the CC5MPX from the device list (see Figure 12-1) and connect to the camera.
- Normally the camera is set to 115200 BAUD. If the BAUD rate is set to something, select the appropriate BAUD rate.
- Once connected to the CC5MPX, use the tabs (see Figure 12-2) to navigate and configure the camera.

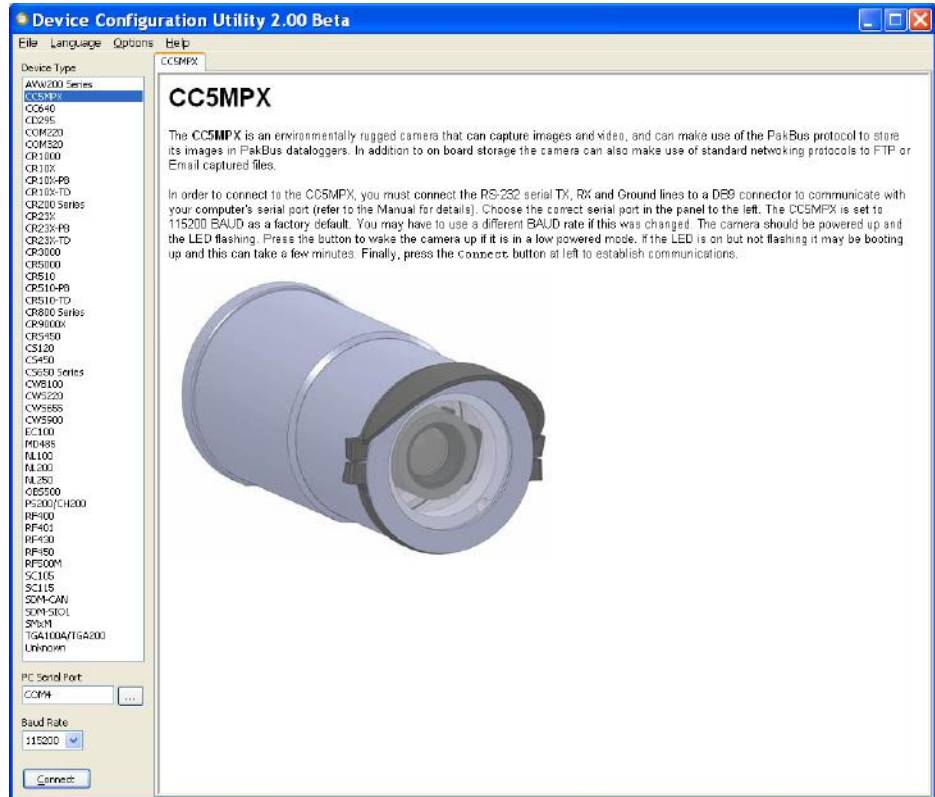

Figure 12-1 CC5MPX Device Configuration Option

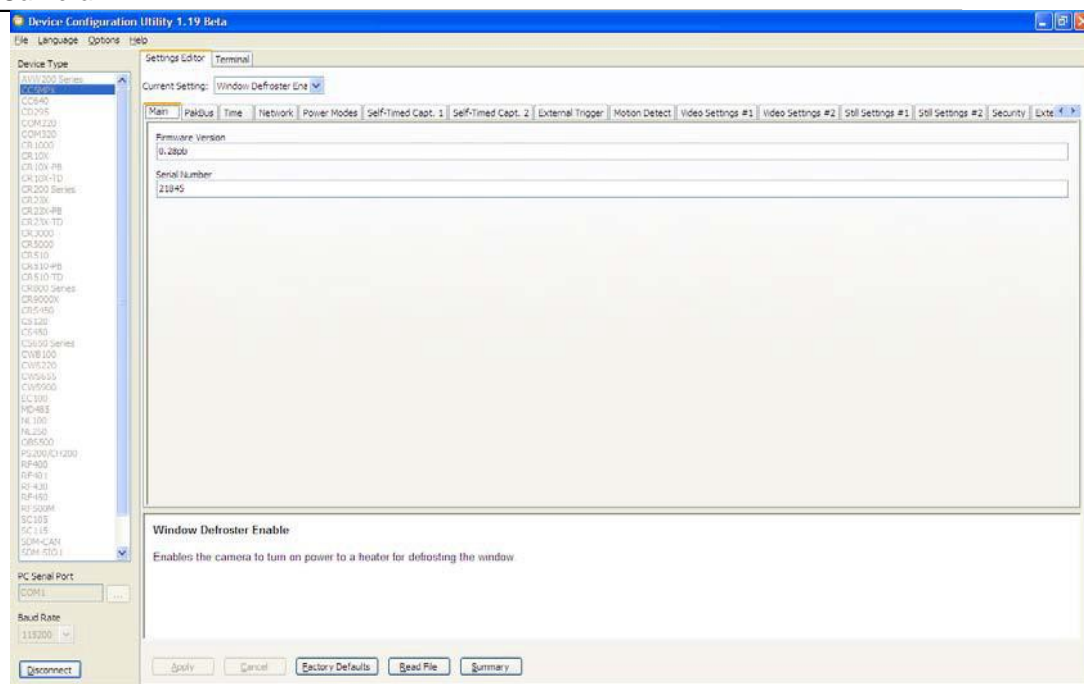

Figure 12-2 Device Configuration Utility Screen

## 13. Image Quality

Lighting conditions have the greatest influence on image quality. The CC5MPX camera produces the best images under normal daylight conditions. Pictures taken in good daylight conditions produce crisper and brighter images, as the camera uses the entire image to adjust the exposure settings of a scene.

Scenes that contain small variations in light intensities will produce better images. In scenes with high variations in light intensities, such as a bright sky or a dark horizon, the image may contain portions that are under-exposed and portions that are over-exposed, as with most cameras. The CC5MPX utilizes various techniques to produce an overall good picture under most lighting conditions.

### 13.1 Night Time Images

In general, the camera does not produce good images at night. If lighting is present, such as street lights, then distinguishable pictures can be taken.

## 14. Lens

The standard and zoom lenses for the CC5MPX contain the following features:

- C-Type Mount
- Varifocal (manual zoom)
- Manual Focus
- DC Iris

Access to the lens for adjusting the zoom and focus requires the removal of the CC5MPX lens tube (see Figure 14-1). The lens tube is threaded on and needs to be turned counter clockwise to be removed.

The zoom and focus adjustments are shown in Figure 14-2. The thumbscrews may need to be loosened prior to moving the adjustments. It is important to tighten the thumb screws once the camera focus and zoom adjustments are completed, to avoid problems from vibration.

The camera controls the iris of the lens using the cable with a 4-pin connector. This connector must always be plugged into the receptacle (on the front lens plate of the camera) for proper operation.

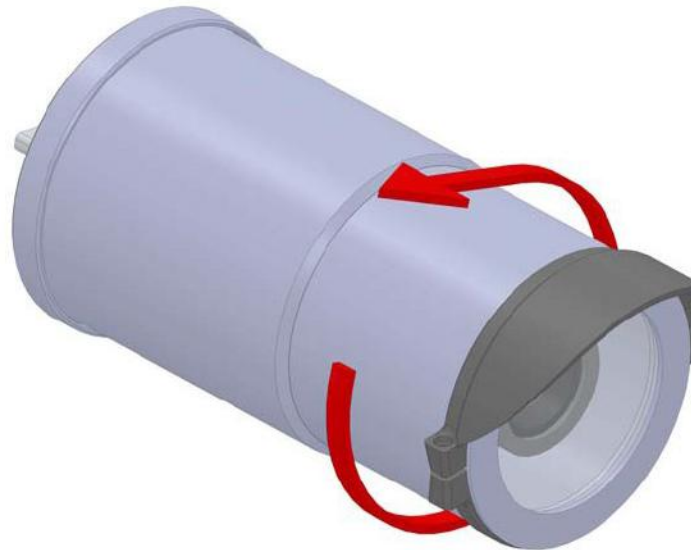

**Figure 14-1 CC5MPX Lens Tube Removal**

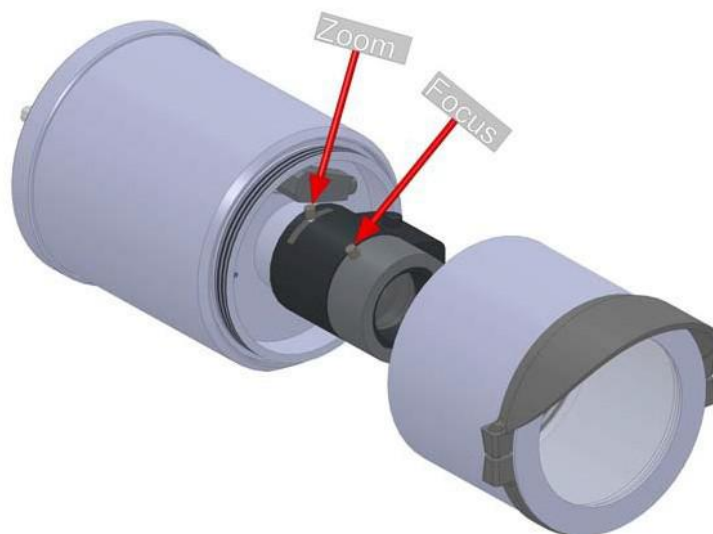

**Figure 14-2 Zoom and Focus Adjustments**

## 14.1 Camera Lens and Field of View

The CC5MPX includes a 4-12 mm lens, which provides an approximate 27° horizontal field of view when fully zoomed in, and an 80° horizontal field of view when fully zoomed out.

The CC5MPX-Z camera includes a 10-40 mm lens, which provides an an approximate 9° horizontal field of view when fully zoomed in, and a 35° horizontal field of view when fully zoomed out.

See Figure 14-3 for a visual representation of the field of view.

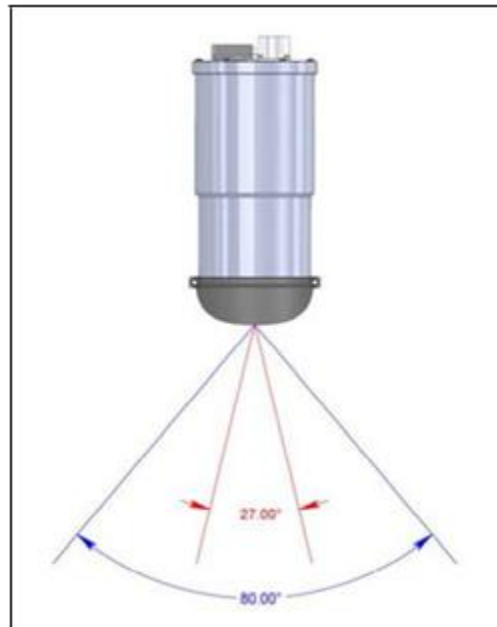

Figure 14-3 CC5MPX Horizontal Field of View

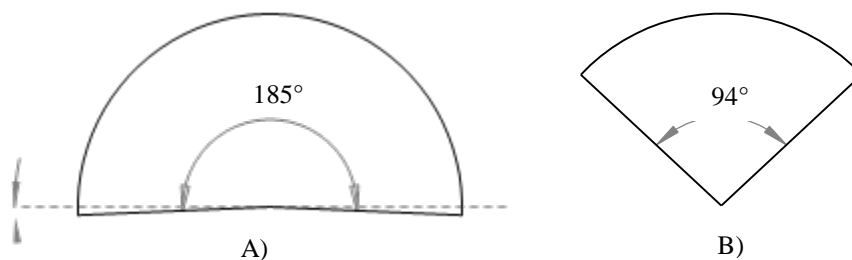

Figure 14-4 Field of View - Fisheye Lens

- A) The lens on the CC5MPXFE can see 5 degrees more than the 185 degrees
- B) The lens on the CC5MPXFE can be adjusted to any value between 94 and 185 degrees

## 14.2 Focus and Zoom Adjustment

To facilitate the focus and zoom adjustment a network connection will need to be established with the camera to view the live video on a web browser.

Refer to Sections 3 and 7 for details on accessing the camera with a web browser.



If the LED is not flashing while the camera is wired up and the power is turned on, you may need to press the setup button to wake the camera from any of its low powered modes. In some configurations, pressing the setup button may also be required to enable the Ethernet port.

Establish a connection to the camera by typing the address of the camera into the web browser (Factory Default IP address is 192.168.1.90). The homepage of the camera should appear once the address is entered.

To view the video, select an appropriate Video Display Size. If you have a direct connection, you will get the best results by displaying the larger 1280 x 720 video. The smaller video display sizes are useful when working with the bandwidth limited connections.

- Loosen the 2 thumb screws on the adjustment rings of the lens. It is generally preferred to adjust the zoom (i.e. frame the scene), and then the focus. Once the zoom is adjusted as desired, tighten the thumbscrew so that the zoom will not inadvertently move when the focus is adjusted.
- Adjust the focus ring and tighten its thumbscrew as well.

---

**Note**

If the camera is targeted on an object that is far away (100 m or more), then it may be beneficial to adjust the lens before taking the camera into the field by using an object that is at a similar distance away.

---

### 14.2.1 Using the Focusing Number

The main purpose of the focusing number is to facilitate focusing the camera when using a display in outdoor sunlight. The sunlight can make it difficult to distinguish fine detail on a computer screen.

The focusing number is displayed on the homepage of the web interface to assist with focusing the CC5MPX camera. The focusing number is a number that generally increases as an images becomes more “in-focus.”

The lens should be adjusted so that the focusing number reads near its maximum achievable value. The numbers are relative and are dependent on the actual scene, so a value of 9000 may be in focus for one scene and a value of 2700 may be the maximum for another scene. The numbers are most useful when the lens is near its best focus position.

The camera should be in a fixed position when using the focusing numbers. If the camera is allowed to move, then movement will account for increasing or decreasing numbers.

There may be instances where the focusing numbers cannot be used to focus the CC5MPX. One such scene may be where a nearby object is desired to be in focus, and the background may be out of focus. However, for most “scene” images where near and far objects are not involved, the focusing numbers work well.

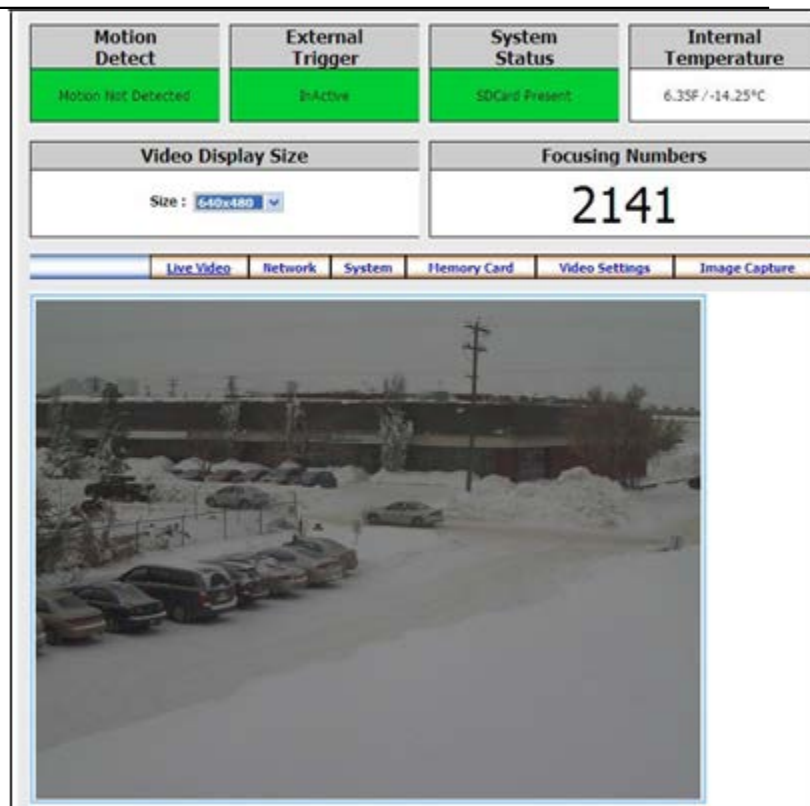

Figure 14-5 Homepage Video Display and Focusing Numbers

### 14.3 Temperature Variations and Focus

The CC5MPX can operate under extreme temperature variations. The focus of the lens can change slightly with large variations in temperature. For example, if a lens is focused at +35°C, the lens may be slightly out of focus at -40°C. The change in focus will be less noticeable if the focus is adjusted closer to the camera's operating temperature.

### 14.4 Lens IR Cut Filter

The CC5MPX is internally equipped with an IR cut filter. The filter is required to filter out near infrared light that can have an undesirable effect on the images.

## 15. Power Calculations and Timings

The CC5MPX was specifically designed for operation in power-constrained systems such as solar powered sites. It is critical in such systems that the camera be properly configured to meet the constraints of the intended application. This section outlines the power consumption of the camera for purposes of power supply design for a system.

### 15.1 Standalone Operation

In standalone mode, the camera operates as a self-contained image and video logger. Files will be stored onto the internal SD memory card.

The current draw of the camera is mainly dictated by the quiescent current draw of the Power Mode, plus the current draw when the camera enters the Fully On power mode (Active Current Draw) to acquire an image or video. TABLE 15-1 shows

some total power consumption (standalone) figures in Amp-Hours per day depending on the Power Mode and frequency of images.

One thing to note is that the Off State will only consume less power than the Deep Sleep state if fewer than 24 pictures are taken per day. This is due to the boot-up time that the camera requires when exiting the Off State. The extra boot-up time means that the camera consumes the Active Current for a longer time (120 seconds).

**Table 15-1 Power Consumption (Standalone)**

Power Mode	Ethernet Power Save Mode	Quiescent Current Draw <u>Max. @12VDC</u>	Active Current Draw <u>Max. @12VDC</u> Active Duration	Amp-Hr Per Day 2 JPG/Hr	Amp-Hr Per Day 1 JPG/Hr	Amp-Hr Per Day 1 JPG/Hr
Fully On	Always On	250 mA	250 mA 0 Sec/JPG	6.0	6.0	6.0
	Full Power Save Mode	200 mA	200 mA 0 Sec/JPG	4.8	4.8	4.8
Partially On	Always On	80 mA	250 mA 0 Sec/JPG	1.92	1.94	2.2
	Full Power Save Mode	10 mA	200 mA 0 Sec/JPG	0.24	0.27	0.54
Deep Sleep	Always On	6 mA	250 mA 0 Sec/JPG	0.15	0.18	0.63
	Full Power Save Mode	6 mA	200 mA 0 Sec/JPG	0.15	0.18	0.53
Off State	Always On	1 mA	250 mA 0 Sec/JPG	0.041	0.22	2.4
	Full Power Save Mode	1 mA	200 mA 0 Sec/JPG	0.037	0.18	1.93

## 15.2 Operation with Communications

The power calculations are more complicated when communications are involved, as the amount of time the camera is Fully On active state is increased by the amount of time it takes for the camera to transfer an image or video.

The transfer times are influenced by two main factors: the size of the image and the transfer speed used to send the image. The amount of time the camera is on will be increased as the size of the image becomes larger or as the communication rate slows down.

To properly determine the power consumption when using communications, the additional time the camera consumes the Fully On current draw needs to be accounted for in the power calculation. Refer to TABLE 15-2 as a guideline for determining the amount of time it takes to transfer files using RS-232 or RS-485 PakBus communications.

<b>Table 15-2 File Transfer Times Using PakBus</b>	
<b>Communication BAUD RATE</b>	<b>Time (seconds) per 100Kbytes</b>
9600	240 seconds 0.0123 A-Hrs
19200	120 seconds 0.0076 A-Hrs
38400	60 seconds 0.0054 A-Hrs
57600	40 seconds 0.0044 A-Hrs
115200	30 seconds 0.0038 A-Hrs

To estimate the power consumption of the system, look up the parameters in TABLE 15-1, along with the communication times to calculate the power consumption as follows:

- Determine the Active Time in minutes:

$$\text{Active Minutes} = \text{Number of pictures per day} * (\text{Active Duration} + \text{Communication Time})/60$$

For a camera in the Deep Sleep state sending 24 images per day at 115200 BAUD that are 100 Kbytes in size:

$$\text{Active Minutes} = 24 * (25 \text{ seconds} + 30 \text{ seconds})/60 = 22 \text{ minutes/day of Active Time}$$

- Determine the total time in Quiescent Low Powered State

$$\begin{aligned} \text{Quiescent minutes} &= 1440 \text{ minutes per day} - \text{Active minutes} \\ \text{Quiescent minutes} &= 1440 - 22 = 1418 \text{ minutes} \end{aligned}$$

- Determine the power consumed by the Quiescent state in Amp-Hours.

$$\begin{aligned} \text{Quiescent power} &= \text{Quiescent minutes} * \text{Quiescent Current Draw}/60 \\ \text{Quiescent power} &= 1418 \text{ minutes} * 6 \text{ mA}/60 = 141.8 \text{ mA-Hour or } \mathbf{0.1418} \\ &\mathbf{\text{Amp-Hours/Day}} \end{aligned}$$

- Determine the power consumed by the Active state in Amp-Hours.

$$\begin{aligned} \text{Active power} &= \text{Active minutes} * \text{Active Current Draw}/60 \\ \text{Active power} &= 22 \text{ minutes} * 250 \text{ mA}/60 = 91.67 \text{ mA-Hour or } \mathbf{0.0917} \\ &\mathbf{\text{Amp-Hours/Day}} \end{aligned}$$

- Total power consumption is the sum of the Active and Quiescent Power

$$\begin{aligned} \text{Total power} &= \text{Quiescent Power} + \text{Active Power} \\ \text{Total power} &= 0.1418 \text{ Amp-Hours/Day} + 0.0917 \text{ Amp-Hours/Day} \\ \text{Total power} &= 0.2335 \text{ Amp-Hours/Day} \end{aligned}$$

## 16. Campbell Datalogger Interface Guide

The CC5PMX can interface with approved Campbell dataloggers (see website) using the RS-232 (default) or RS-485. The RS-232 configuration is the simplest option as it does not require an additional hardware interface (see Section 13 *RS-232 Communications*). The pigtail end of the CC5PMX Power & I/O cable can be terminated directly to the CR1000/CR3000 datalogger wiring panel control ports (COM1-4). Refer to Section 8 *Cables/Wiring* for wiring details.

The CC5PMX RS-485 interface can also be used, but does require the use of an MD485 interface to provide conversion of the RS-485 signal (see Section 14 *RS-485 Communications*). The MD485 can connect to the datalogger using the CS I/O port or the RS-232 port. Refer to the MD485 manual for additional information.

### 16.1 Datalogger Memory Setup

To facilitate the storage of photos, a CFM100 allows the use of a compact flash card on the CR1000/CR3000 datalogger. Memory can also be allocated from the datalogger internal memory to create a virtual user drive – USR. Entering a non-zero value for the parameter *USR:drive size* allocates internal memory for the drive. The amount of memory required varies depending on each application. A good number to start with is approximately 1048 Kbytes, which is 25% of the 4M bytes available on a standard datalogger.

The following methods can be used to set the drive size of the USR:

- The *Device Configuration Utility*
- PakBus Graph
- Editing the parameter from the Status Table
- datalogger optional keypad and display

---

**Note** The CC5PMX will not send any files using the PakBus that are greater than 2 MB.

---

### 16.2 Datalogger Files Manager

The *Files Manager* setting on the datalogger facilitates the management of jpeg and avi files that are received from the camera. *Files Manager* allows the user to specify a name for the files and the number of files kept in a ring memory type fashion.

Once *Device Configuration* is opened, selected the *Advanced* tab. This displays the *Files Manager*.

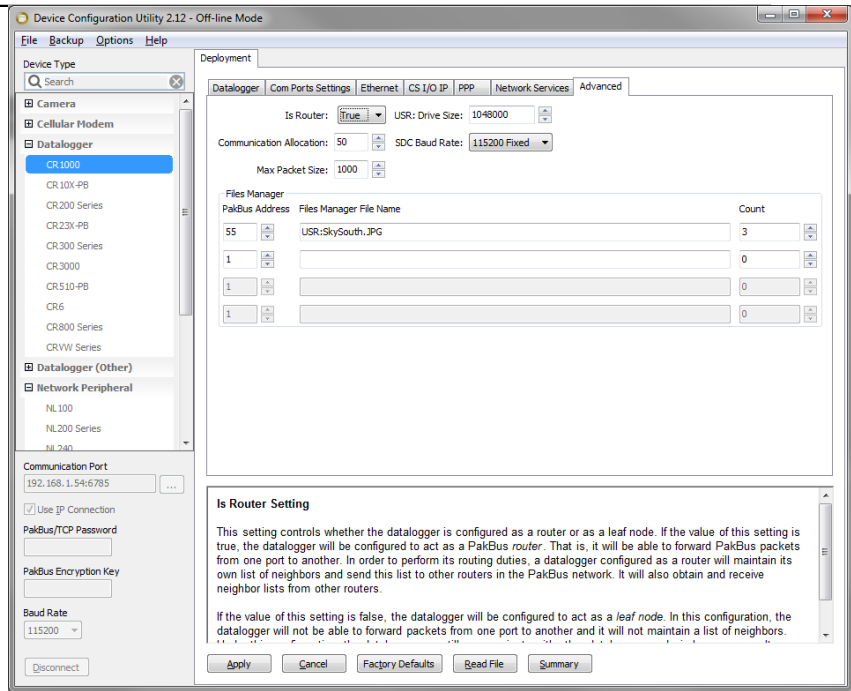

**Figure 18.1 Datalogger Files Manager**

For the *PakBus Address* use address of the camera. Default is 55.

Under *Files Manager File Name* use the format listed below.

(DDD:NAME.EXT)

- DDD – destination drive on the CR1000/CR3000 datalogger. USR for the user drive. In figure 18.1 this value is *USR*. CRD for the compact flash memory card.
- NAME – any name string that will be used to name the files. In Figure 18.1 this value is *SkySouth*. The file name will automatically produce an incrementing number. For example, the first file will be named *SkySouth1.jpg*. Entering a zero for this parameter will disable the automatic numbering and produce a fixed file name. In this example, the *Files Manager File Name* would be *USR:0.JPG*.
- EXT – the file extension of the incoming file must match. In the case of the camera, this must always be either jpg or avi. In Figure 18.1 this value is *JPG*.

*Count* dictates the maximum number of files stored with this file name. If the datalogger processes more files than specified, the datalogger will delete the oldest file.

## 16.3 Datalogger COM Port (Control Port) Communications

On the datalogger, a pair of control ports can be configured to function as RS-232 communication (COM) ports. Any of these 4 COM ports can be configured as PakBus ports and used to communicate with the camera.

The COM ports can be activated as PakBus ports using the *Device Configuration Utility* or by using the SerialOpen instruction in the datalogger program.

The following SerialOpen instruction configures COM Port 2.

- `SerialOpen(Com2,115200,4,0,1000)`
- BAUD rate - 115200
- SerialOpenFormat – 4
- Transmit delay – 0
- Buffer size – 1000

## 17. Remote Image Retrieval

Once the camera has transferred an image or video to a datalogger, existing LoggerNet communications can be used to retrieve images and video remotely from the datalogger memory.

There are also permanent links available in the CC5MPX webserver to download the most recently captured images or video files that have been saved to the SD card. Refer to Section 5.4.1 for details.

### 17.1 LoggerNet File Retrieval

LoggerNet (version 4.0 or newer) includes the File Retrieval setup that facilitates the image and video file retrieval from PakBus dataloggers (CR800 series, CR1000, and CR3000). The File Retrieval tab is located in the Setup Screen as part of the datalogger configuration. Once configured, the File Retrieval software is used to retrieve images and video from a datalogger.

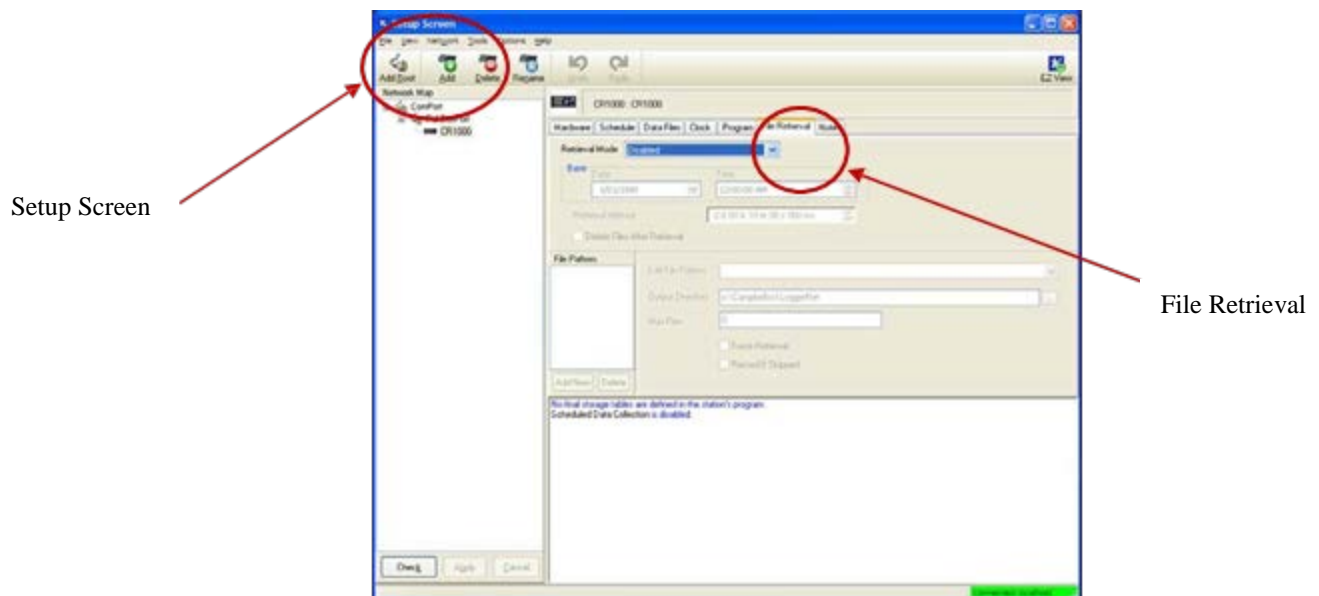

**Figure 17-1 File Retrieval Setup Screen**

Select the required Retrieval Mode for the application. The use of the “Follow Scheduled Data Collection” option will use the scheduled configuration in the Schedule Tab. If the “New Schedule” option is selected, you will need to configure the Base Date and Time, and Retrieval Interval parameters.

It is possible to configure the File Retrieval to delete files once retrieved from the datalogger. If datalogger memory capacity is a concern, it is recommended to use this feature.

To add a file retrieval process, start by clicking “Add New” under File Pattern. Once added, the Edit File Pattern, Output Directory, and Max Files parameter become available to fill out. Each File Pattern added will need to be individually configured.

Under the Edit File Pattern parameter you must select from the directory location options, in order to specify the image or video to be retrieved. By default, the jpg and avi names are a wild card (\*), which means all jpg or avi files in the specified directory will be retrieved. If you have used specific filenames in the camera configuration, you are able to specify these names in the File Edit Pattern parameter. It is possible to configure multiple File Patterns to collect images or video on different schedules or from multiple directories.

---

**Note**

If your version of LoggerNet File Retrieval does not list the avi files as an option under File Edit Pattern, you are able to force the filename and format.

---

The default Output Directory is C:\Campbellsci\LoggerNet. If required, you are able to change this by browsing to the preferred location. The Max Files parameter specifies the maximum number of files that can be retrieved during each scheduled event. The newest files will be retrieved.

When the Force Retrieval box is selected, a file that matches the file pattern will be retrieved regardless of the file’s timestamp or whether the file has already been retrieved. When the Record If Skipped box is selected, the names and dates of any files that are not retrieved because of the Max Files parameter will be recorded and they will not be retrieved later. If this box is not selected, the skipped files can be retrieved in a later attempt.

## 17.2 Using LoggerNet File Control

Images or video that are in the dataloggers memory can be viewed or collected on demand by using the File Control feature that is available from the Connection Screen menu (Figure 17-2). The use of File Control requires a communications connection to the datalogger. Using the File Control can also be useful for debugging purposes.



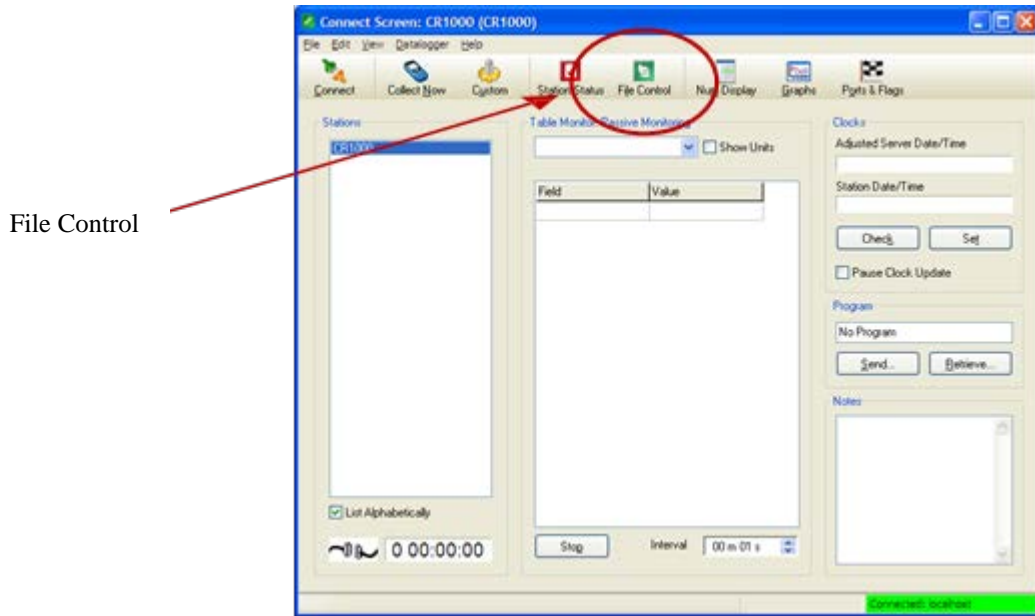

**Figure 17-2 Loggernet Connection Screen**

In dataloggers such as the CR1000, the Device Map can include the CPU, USR, and the CRD (compact flash module). The devices show up in the left hand side of the File Control panel. To view files of a certain device, simply click on the desired device listed in the panel (Figure 17-3). Use the “Retrieve” button to download the image from the datalogger.

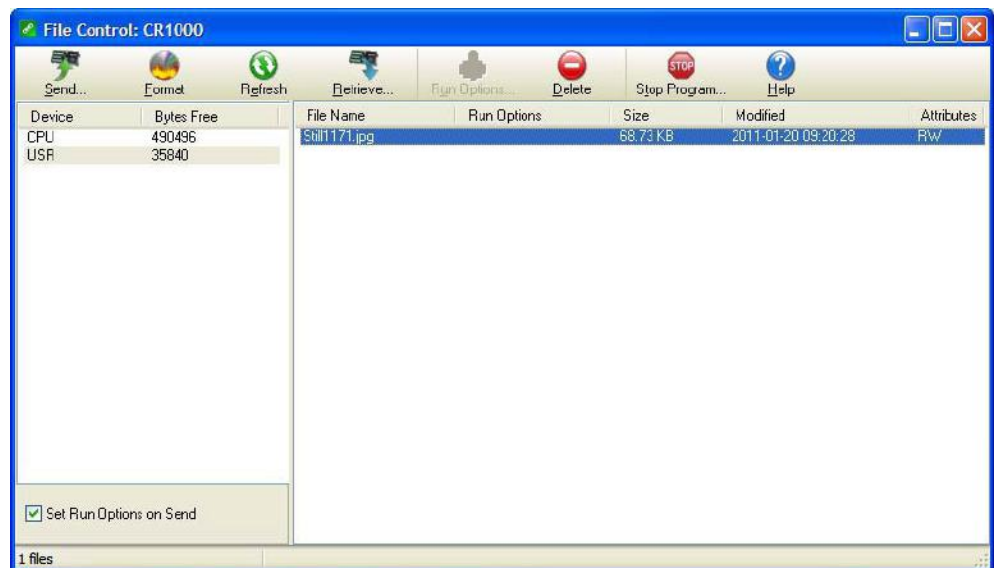

**Figure 17-3 USR Drive View in File Control**

## 18. Installation

The camera enclosure is designed to be environmentally sealed for outdoor installations. The enclosure provides protection from moisture or high humidity. It is not intended for operation under water. All that is required is an appropriate mounting fixture.



**Figure 18-1 CC5MPX Mounting Kit**

The camera is equipped with a set of three ¼-20 threaded mounting holes (see Figure 18-2). These mounting holes are centered along the bottom of the camera and are spaced 1.0" (25.4 mm) apart from one another. At least two of the ¼-20 threaded holes are required for mounting the camera.



**Figure 18-2 CC5MPX Mounting Holes**

When using the optional Mounting Kit, align the outer holes of the CC5MPX with the center hole and the 180° slot of the mount. Loosely secure the two together with the two ¼-20 x 0.5" Hex bolts included with the kit. It is now possible to mount the CC5MPX to either a crossarm or other mounting surface with the included u-bolt.

With the hardware loose, the camera and the L18549 can be pivoted to allow a full range of motion when aiming the camera. The hardware should be secured once the camera is properly aimed at the intended target.

The focus of the camera should be checked and adjusted as required. Refer to Section 14.2 *Focus and Zoom Adjustment* for details. Be sure that the lens tube is fully seated, the sun shroud is properly oriented after the camera is aimed, and any protective caps are properly secured.

The sun shroud can be adjusted by loosening the Philips screws and turning the shroud. When tightening the screws back up, do not over tighten the screws as the shroud may crack. A light torque is all that is required to hold the shroud in place.

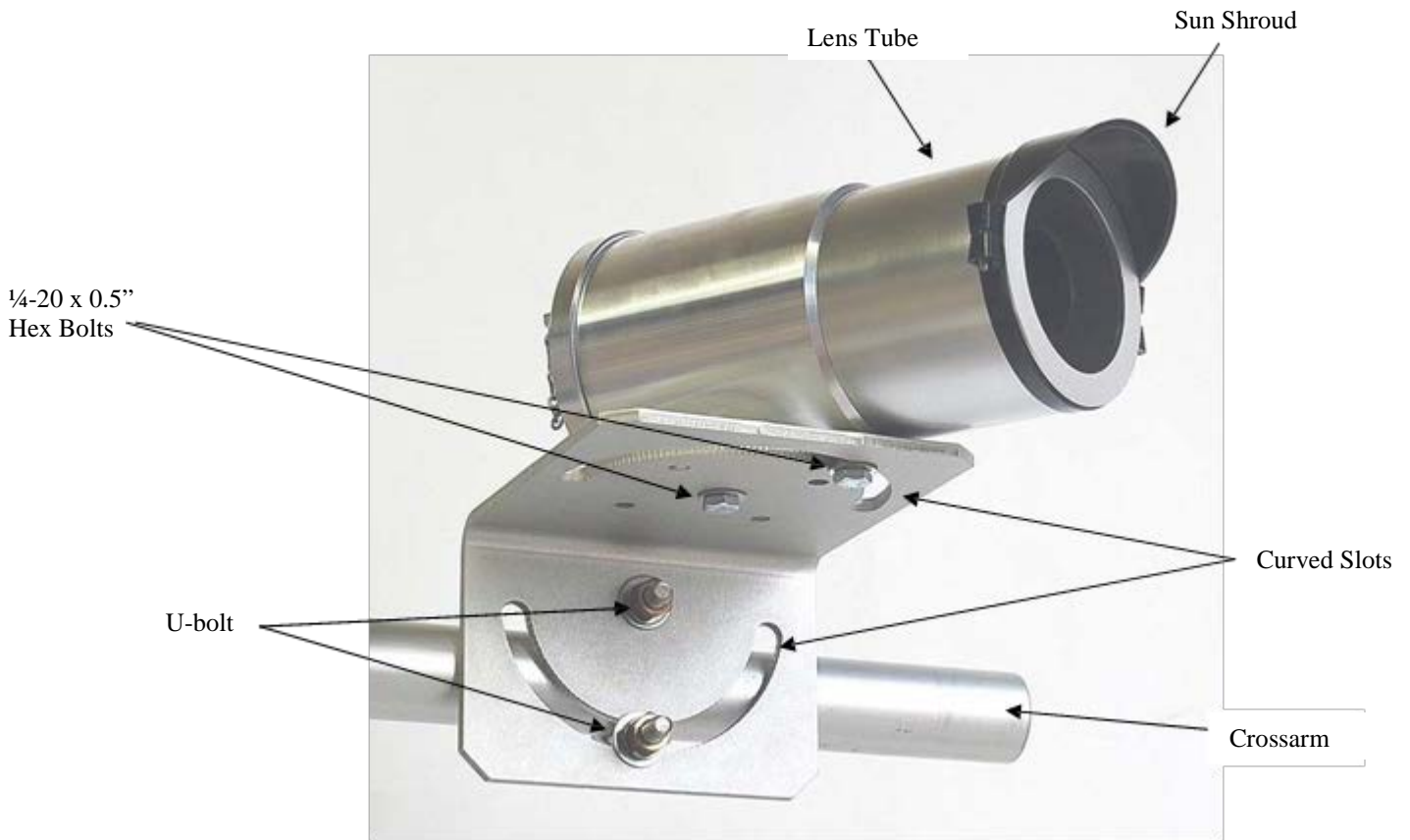

Figure 18-3 CC5MPX Mounted to Crossarm

## 19. Maintenance

The CC5MPX requires little maintenance and no calibrations. Keeping the camera clean is important for the longevity of the camera and image and video quality.

### 19.1 Lithium Battery

The camera is equipped with a Lithium Thionyl Chloride battery. The battery maintains the clock functionality for periods when power is not connected to the camera. The expected battery life is 10 years. It is recommended that the battery be replaced by a certified repair facility.

## 19.2 Window and Lens Cleaning

If the enclosure window or lens requires cleaning, it is very important that only a proper lens cloth or lens tissue be used. The use of inappropriate materials to clean the lens or window can permanently damage the surface and reduce the clarity.

## 19.3 CC5MPX O-Rings

There are three O-rings that should be inspected on the camera. If any of the O-rings look cracked or damaged, they require replacement. The locations of the three O-rings are shown in figures 19-1 to 19-3.

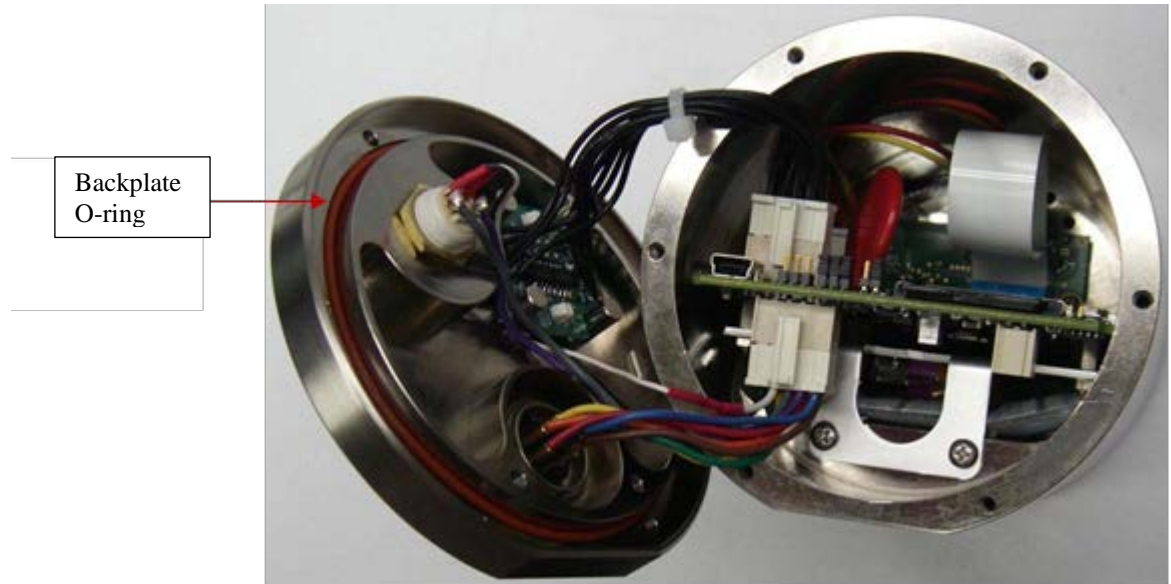

Figure 19-1 Backplate O-ring



Figure 19-2 Button Cap O-ring



**Figure 19-3 Front Main Body O-ring**

It is recommended that the O-rings be inspected whenever opened, or at a minimum every two years (with desiccant replacement) to ensure that the seal integrity is maintained. Contact Campbell Scientific for details on replacement parts.

It is important to note that the Button Cap O-ring and the Front Main Body O-ring are both glued into place to prevent the O-rings from inadvertently falling out. Do not attempt to remove these O-rings unless they are being replaced.

## 19.4 CC5MPX Desiccant

The CC5MPX contains three small desiccant packets inside the camera. If the camera is frequently opened (i.e. backplate of lens tube removed), then the desiccant packets of the camera should be replaced annually. Otherwise, the desiccant packets should be replaced every two years as preventative maintenance.

The desiccant that is supplied with the camera is an indicating type of desiccant. There is a small viewing window on the packet that shows the color of the desiccant. If the desiccant is blue, it is good. If the desiccant is pink, it is saturated with moisture.

The desiccant packets are located under the PCB on the bottom of the camera (see Figure 19-4). Needle nose pliers will be useful in helping remove and reinsert the three desiccant packets.

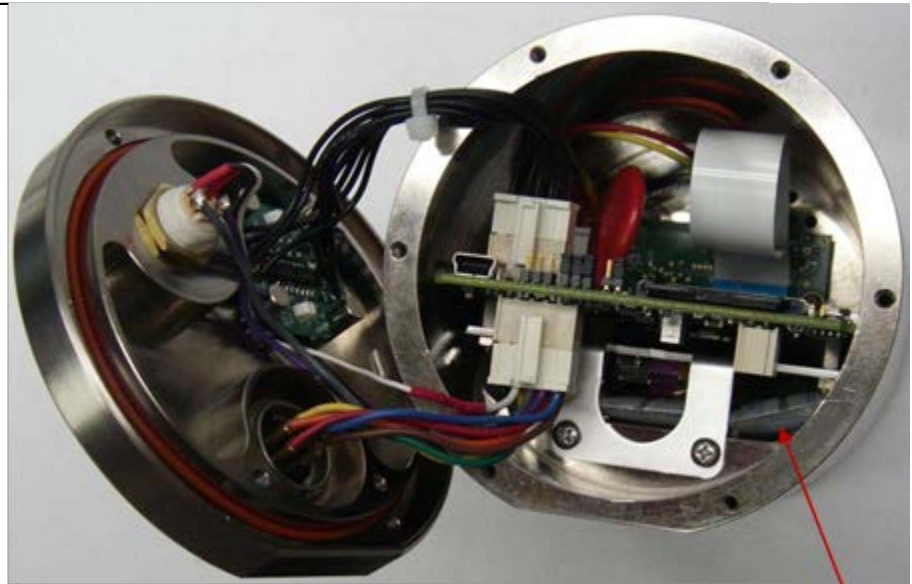

**Figure 19-4 Desiccant Location**

Location of  
Desiccant

## 20. Backplate Removal Procedures

It is necessary to remove the backplate for the following reasons:

- Access to the SD memory card
- Change internal jumper positions
- Replace desiccant
- Inspect O-rings

If the camera is powered up and operating (LED flashing), properly shutdown the camera by holding down the setup button for more than 10 seconds continuously. Alternatively, the Shutdown button can be used from the Live Video Homepage of the camera. Once the LED stops flashing, remove the CC5MPX from any power supply and disconnect any attached cabling.

To remove the backplate, start by removing the six Philips screws located along the perimeter of the backplate (see Figure 20-1). Note that there are two washers included with protective cover chains of the bottom cap and the RJ45 cap.

After the screws are removed, gently pull the backplate out. The backplate will still be attached to the camera with the wires. Do not remove the wires. Pivot the backplate to the left side of the camera. You will now have access to the inside of the camera.

When replacing the backplate ensure that the O-ring is still seated properly on the backplate (see Figure 19-1). This is very important as the O-ring is required to properly seal the camera.

The backplate can only be seated in the orientation that aligns the flat surfaces of the backplate and the bottom of the camera body. This will also help align the screw holes. The six screws can now be threaded and hand tightened. Be sure the two plastic washers are located between the tether chains and the backplate.



Figure 20-1 Backplate View

## 21. System Limitations

This section outlines some system limitations that exist in the CC5MPX camera.

### 21.1 High Resolution 5 Megapixel Images

The capturing of 5MP pictures results in longer capture times than other image resolutions. When a 5 MP image is captured, the continuous video stream is paused, the image sensor is reconfigured and then the 5MP image is captured. This longer delay time would be noticeable when capturing images from the external trigger. 5MP images would take several seconds from the external trigger signal being asserted. All other still image captures are less than 1 second.

### 21.2 Simultaneous Processes

The CC5MPX cannot capture 2 event simultaneously. For example, the CC5MPX cannot capture a still image while video is being recorded. Also other processes such as downloading files from the memory card can add additional delays to the capture process.

## 22. Internal USB Function

The internal USB port in the camera currently only has one function. It provides a backdoor for setting up the Network interface on the camera. When first connected to a PC the following window will appear:

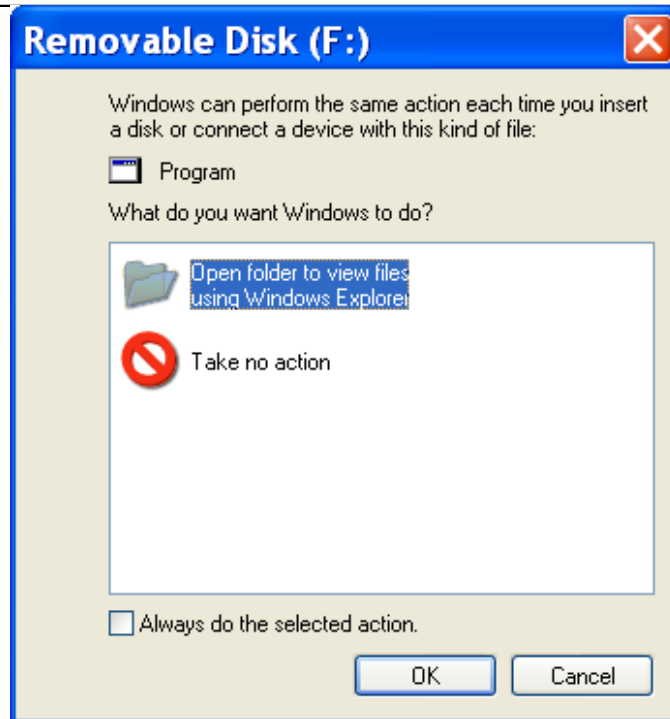

**Figure 22-1 USB Network Interface**

Select *Open folder to view files*.

The following will be the viewable files:

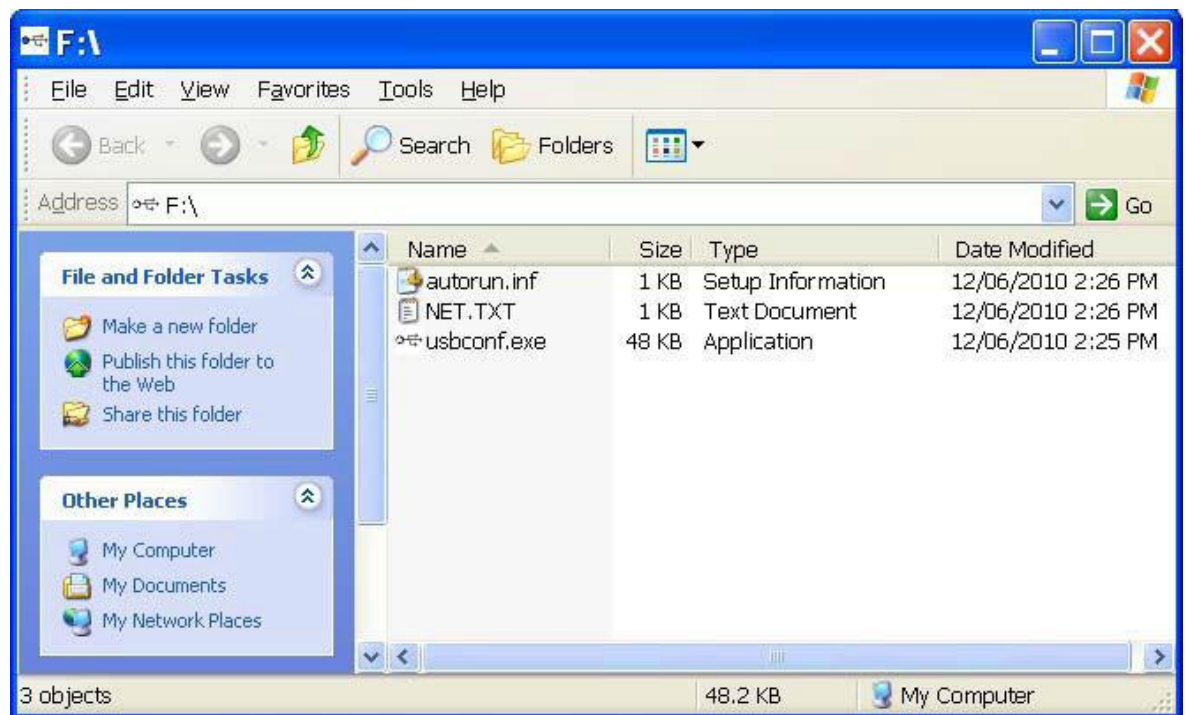

**Figure 22-2 CC5MPX USB Directory**

Run the executable file *usbconf.exe*.



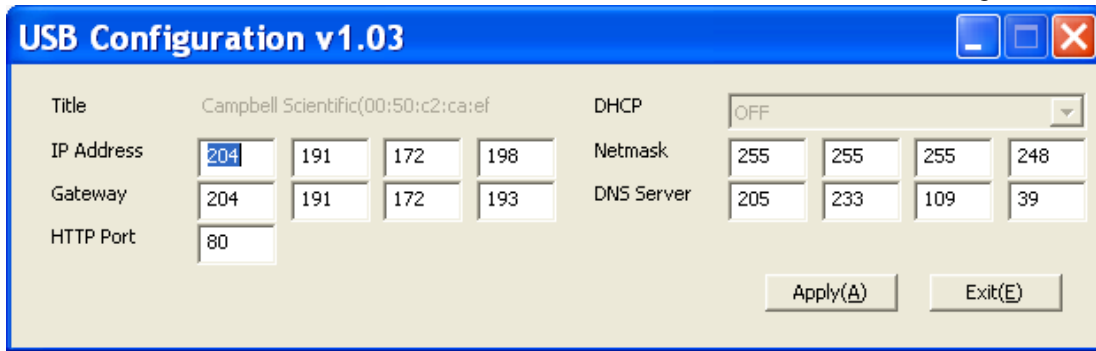

**Figure 22-3 Network Configurations**

At this point you can confirm or edit the IP address settings. If changes are made, the apply button must be selected followed by Exit. **Do not unplug the USB cable or shutdown the camera at this point.** The USB device must be safely removed before unplugging the cable or shutting down the camera, otherwise the changes will be lost.

## 23. Quick Notes

### 23.1 CC5MPX General

- The LED will flash or be on when the camera is in an Active Power State.
- When the LED is steadily on, the camera is booting up. Avoid interrupting this process.
- Briefly pressing the setup button will always cause the camera to exit from any low powered quiescent states and enable the Ethernet interface for communications. The camera will remain in this state for 5 minutes.
- An active session to the camera with a web browser will prevent the camera from entering a low powered state.
- Avoid removing power from the camera when it is in an active state. If the camera is in an active state (LED is flashing), properly shutdown the camera to avoid any memory card corruption before removing power. The camera can be shut down by pressing the setup button continuously for more than 10 seconds or by using the shutdown button on the web interface.
- The SD memory card must be formatted to FAT32.
- If a memory card is removed from the CC5MPX to read or download its contents, do not delete or add files manually. If it is desired to delete files from the card, it is recommended to reformat the entire card (using FAT32) or to use the CC5MPX web interface to delete them.
- Verify that the lens cable is properly seated, as the connector may inadvertently become unplugged during handling or installation.

- Always ensure that all cable connectors, covers and the lens tube are securely in place.
- Record any changes to the IP settings of the camera. This information is important to gain access to the camera for focusing, or reconfiguration.
- The camera configuration file can be saved or loaded via the web interface. This feature can be found under the System and Image Capture tabs.
- Check the Campbell Scientific website for firmware updates that may apply.

## 23.2 Campbell Dataloggers Users

- If interfacing to a datalogger, ensure that your datalogger has the appropriate PakBus operating system.
- Use either the CC5MPX built in web interface, the Device Configuration Utility of PakBus Graph to change settings in the camera.
- Use the Device Configuration Utility to change settings in MD485 or other PakBus devices.
- The Device Configuration Utility can also be used to set the datalogger memory and PakBus parameters.
- Files must be less than 2 Mbytes for PakBus transmissions.
- The datalogger instruction *SendVariable* can be used to send variables or text to the camera, for use in image or video banners. The instruction can also be used to control the window defroster.

## 23.3 Configuration Process

1. Determine what will trigger the capture of an image or video. Options are:
  - a. Time – Enable and configure Self-Timed Capture 1, Self Timed Capture 2, or both.
  - b. External Signal – Enable and configure the External Trigger Capture.
  - c. Motion Detect – Enable and configure Motion Detect Capture.
2. Select the Power Mode that best suits your requirements (see Table 23-1 Power Mode Summary). Options are:
  - a. Fully On – Used if no power constraints exist or if high performance is required.
  - b. Partially On – Provides substantial reduction in power (especially with the Ethernet Power Mode set to Full Power Save).
  - c. Deep Sleep – Provides very good power savings. The camera does not need to reboot when activated by a trigger. Recommended to use if more than 24 triggers are expected per day.

d. Off Mode – Offers the best power savings mode. Useful if less than 24 images or video captures are required per day. It takes about 90 seconds for the camera to wake up to start acquiring a picture.

<b>Power Mode</b>	<b>Ethernet Power Save Mode</b>	<b>Quiescent Current Draw Max. @12 VDC</b>	<b>Time (Seconds) from wakeup to start of capture</b>	<b>Time (Seconds) in Fully On Mode (Active Current Draw)</b>
Fully On	Always On	250 mA	< 1	0 – Always Active
	Full Power Save Mode	200 mA	< 1	0 – Always Active
Partially On	Always On	80 mA	10	20
	Full Power Save Mode	10 mA	10	20
Deep Sleep	Always On	6 mA	15	25
	Full Power Save Mode	6 mA	15	25
Off State	Always On	1 mA	90	120
	Full Power Save Mode	1 mA	90	120

3. Set the details of the still image or video

- a. Set the still image settings
- b. Set the video settings

4. Set other details related to Communications and I/O. These other parameters are located under:

- a. Network
- b. System
- c. Communications

# ***Appendix A. CC5MPX Series Cameras and Accessories***

---

## **A.1 CC5MPXWD**

**Ordering part numbers:**

1. CC5MPXWD

**Details:**

\* CC5MPX with window defroster

## **A.2 CC5MPX with Zoom Lens**

The option of a CC5MPX with a zoom lens is available when required for specific applications.

**Order Model:**

1. CC5MPX-Z

**Details:**

\* Lens has 10-40 mm focal length

\* Lens has 9° to 35° field of view

\* Requires use of C2681 for window defroster option

## **A.3 CC5MPXFE**

**Ordering part numbers:**

1. CC5MPXFE

**Details:**

\* Lens has 1.4-3.1 mm focal length

\* Lens has 94° to 185° field of view

## **A.4 Window Defroster**

Both models of camera are available with a factory installed window defroster option. The window defroster is useful in preventing and removing light frost and icing from the camera window. See Appendix B for further details.

1. C2681

**Details:**

\* CC5MPX-Z window defroster

\* Factory install only

## **A.5 Power & I/O Cable**

Two power & I/O cable options are available. The choice between the cable options is dependent on the addition of either window defroster. If the application calls for the use of the window defroster then the CC5MPXPWRCBL2-L is recommended. The reason for offering the

CC5MPXPWRCBL2-L is that it allows for cables of up to 30 m. The CC5MPXPWRCBL-L can be used when the window defroster is installed but the cable length is limited to 9 m.

**Ordering part numbers:**

1. CC5MPXPWRCBL-L (-L is length in feet)

**Details:**

- \* 24-AWG 3 Pair individually shielded cable with Santoprene jacket
- \* 6-pin environmental connector
- \* Maximum length 30 m (100 ft)
- \* Includes 3 single pole 16-20AWG grey push operated connector terminals for unused wires

2. CC5MPXPWRCBL2-L (-L is length in feet)

**Details:**

- \* 20-AWG 1-pair (power) & 24-AWG 2-pair shielded cable with polyurethane jacket
- \* 6-pin environmental connector
- \* Maximum length 30 m (100 ft)
- \* Includes 3 single pole 16-20AWG grey push operated connector terminals for unused wires



Figure A-1 CC5MPXPWRCBL2-L

## A.6 Environmental Ethernet Cable

**Ordering part numbers:**

1. RJ45ENVCBL-L (-L is length in feet)

**Details:**

- \* 26-AWG 4 Pair (8 conductor) Shielded CAT5E Cable with polyurethane Jacket
- \* RJ45 Environmental Connector on one end and regular RJ45 connector on the other end
- \* Maximum length 70 m (230 ft)



Figure A-2 RJ45ENVCBL-L

## A.7 L18549 Mounting Kit

**Details:**

\*Mounting kit with U-bolt and fasteners



Figure A-3 L18549 Mounting Kit

The L18549 can mount up to a 1.5" O.D. pipe.

## A.8 C2469 DB9 FEMALE To Terminal Block Adaptor

**Details:**

\* Adaptor 9-PIN female RS-232 to screw terminal block

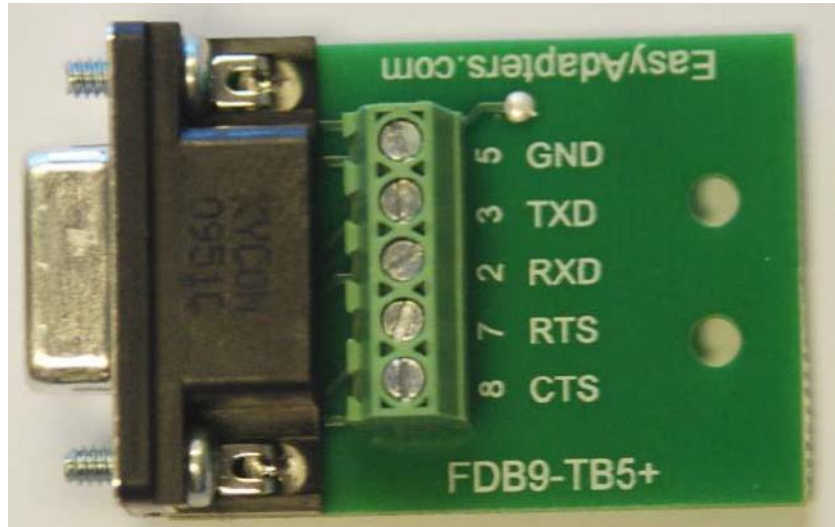

Figure A-4 C2469 DB9 FEMALE To Terminal Block Adaptor

## A.9 C2641 Desiccant

**Details:**

\* Silica gel indicating desiccant. 2 gram MiniPax (3 per camera)



Figure A-5 C2541 Desiccant

# ***Appendix B. Window Defroster Option Specifications (Parts C2670 or C2681)***

---

## **B.1 Power Supply**

---

**Note**      **\* Warning: The CC5MPX is specified to operate on a 9-30 VDC supply input range. When the window defroster is installed the 30 VDC maximum must be reduced to 16 VDC. Operating the CC5MPX with window defroster at voltages greater than 16 VDC can cause damage to the CC5MPX.**

---

Operating voltage:                      9-16 VDC\*  
CC5MPX Current Consumption with Defroster On:  
   1.2 Amps Max. @ 16 VDC  
   1.0 Amps typical on 12 VDC systems

## **B.2 Description**

The window defroster consists of an aluminum ring with a resistive type heating element (see Figure B-1 CC5MPX Window Defroster). The CC5MPX can be programmed to turn on the power to the heater based on the internal temperature reading of the camera. The on duration can also be set on the CC5MPX camera. Refer to Section 11.3 for details on datalogger control of the window defroster via PakBus.

The heating element is nominally 18 Ohms in resistance. The current draw will vary with the allowable input voltage range of 9 to 16 VDC. The current draw from the CC5MPX and heater combined is 1.2 Amps max at 16 VDC and is typically 1.0 Amps on a Nominal 12 VDC system. It is recommended to use the CC5MPXPWRCBL2-L with the window defroster option.

The window defroster is useful in preventing and removing light frost and icing from the camera window. With extreme icing or riming conditions and low temperatures, the window defroster may not be able to clear the window due to power constraints of the defroster.

Springs are used to press the window defroster against the window. It is normal for the window defroster to leave marks on the window. These marks are outside of the camera's viewing angle (see Figure B-2 Window Defroster with Lens Tube).





**Figure B-1 CC5MPX Window Defroster**



**Figure B-2 Window Defroster with Lens Tube Installed**

## CAMPBELL SCIENTIFIC COMPANIES

### **Campbell Scientific, Inc. (CSI)**

815 West 1800 North  
Logan, Utah 84321  
UNITED STATES

[www.campbellsci.com](http://www.campbellsci.com) • [info@campbellsci.com](mailto:info@campbellsci.com)

### **Campbell Scientific Centro Caribe S.A. (CSCC)**

300N Cementerio, Edificio Breller  
Santo Domingo, Heredia 40305  
COSTA RICA

[www.campbellsci.cc](http://www.campbellsci.cc) • [info@campbellsci.cc](mailto:info@campbellsci.cc)

### **Campbell Scientific Africa Pty. Ltd. (CSAf)**

PO Box 2450  
Somerset West 7129  
SOUTH AFRICA

[www.csafrica.co.za](http://www.csafrica.co.za) • [sales@csafrica.co.za](mailto:sales@csafrica.co.za)

### **Campbell Scientific Ltd. (CSL)**

80 Hathern Road, Shepshed, Loughborough LE12 9GX  
UNITED KINGDOM

[www.campbellsci.co.uk](http://www.campbellsci.co.uk) • [sales@campbellsci.co.uk](mailto:sales@campbellsci.co.uk)

### **Campbell Scientific Southeast Asia Co., Ltd.**

877/22 Nirvana@Work, Rama 9 Road  
Suan Luang Subdistrict, Suan Luang District  
Bangkok 10250  
THAILAND

[www.campbellsci.asia](http://www.campbellsci.asia) • [info@campbellsci.asia](mailto:info@campbellsci.asia)

### **Campbell Scientific Ltd. (France)**

3 Avenue de la Division Leclerc  
92160 ANTONY  
FRANCE

[www.campbellsci.fr](http://www.campbellsci.fr) • [info@campbellsci.fr](mailto:info@campbellsci.fr)

### **Campbell Scientific Australia Pty. Ltd. (CSA)**

PO Box 8108  
Garbutt Post Shop  
QLD 4814 AUSTRALIA

[www.campbellsci.com.au](http://www.campbellsci.com.au) • [info@campbellsci.com.au](mailto:info@campbellsci.com.au)

### **Campbell Scientific Spain, S. L.**

Avda. Pompeu Fabra 7-9  
Local 1 - 08024 BARCELONA  
SPAIN

[www.campbellsci.es](http://www.campbellsci.es) • [info@campbellsci.es](mailto:info@campbellsci.es)

### **Campbell Scientific do Brazil Ltda. (CSB)**

Rua Apinagés, n.br. 2018 - Perdizes  
CEP: 01258-00 São Paulo SP BRAZIL

[www.campbellsci.com.br](http://www.campbellsci.com.br) •  
[vendas@campbellsci.com.br](mailto:vendas@campbellsci.com.br)

### **Campbell Scientific Ltd. (Germany)**

Fahrenheitstrasse13, D-28359 Bremen  
GERMANY

[www.campbellsci.de](http://www.campbellsci.de) • [info@campbellsci.de](mailto:info@campbellsci.de)

### **Campbell Scientific Canada Corp. (CSC)**

14532 – 131 Avenue NW  
Edmonton, Alberta T5L 4X4  
CANADA

[www.campbellsci.ca](http://www.campbellsci.ca) • [dataloggers@campbellsci.ca](mailto:dataloggers@campbellsci.ca)

### **Campbell Scientific (Beijing) Co., Ltd.**

8B16, Floor 8 Tower B, Hanwei Plaza  
7 Guanghua Road, Chaoyang, Beijing 100004  
P.R. CHINA

[www.campbellsci.com](http://www.campbellsci.com) • [info@campbellsci.com.cn](mailto:info@campbellsci.com.cn)